



LIK HUNG

METAL MANUFACTURING LTD.

力雄金屬製品有限公司

2021 CATALOGUE

Cable Trunking

Cable Tray

Cable Ladder

Cable Basket

電線槽

電纜托盤

電纜梯架

電線籃

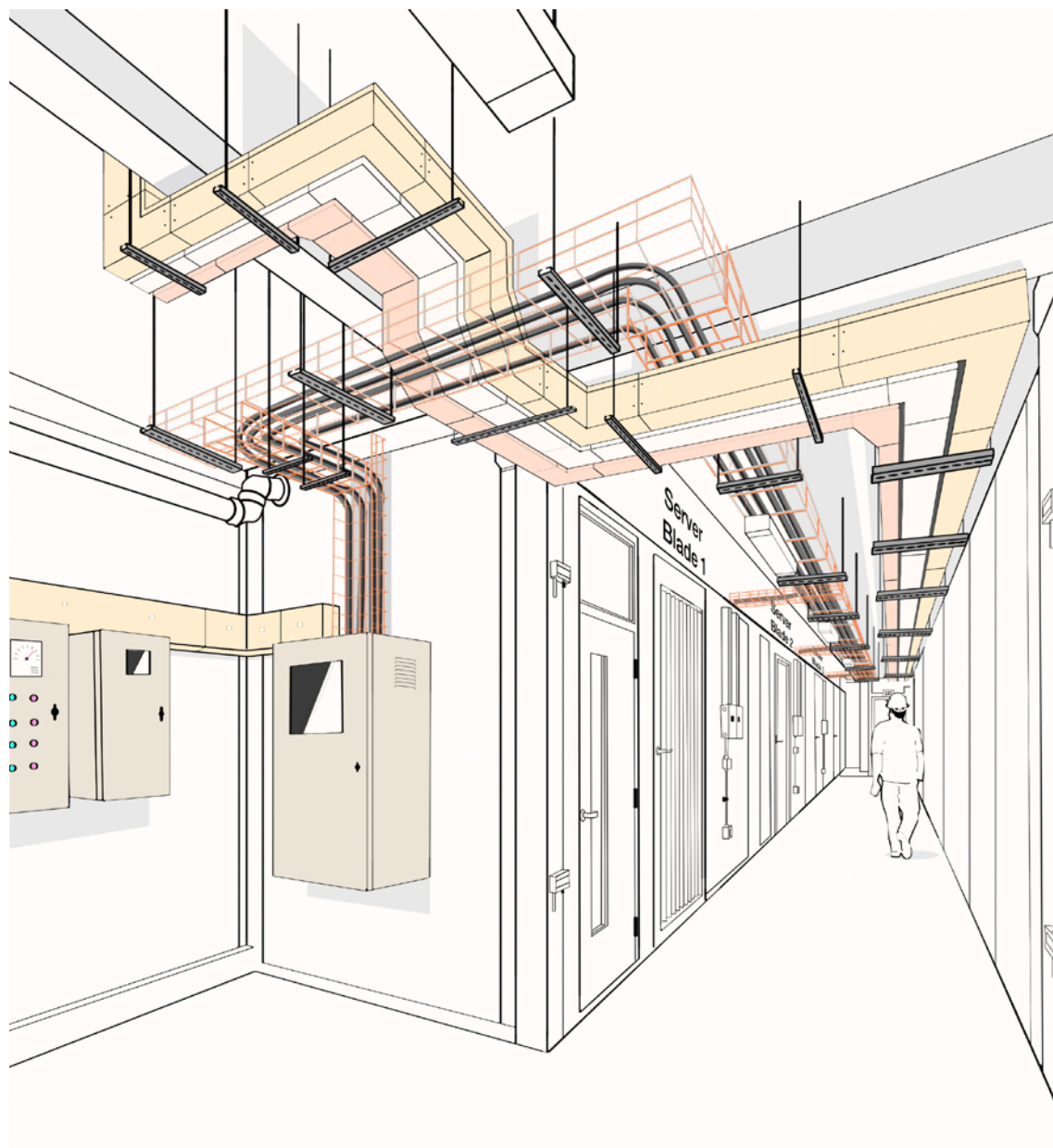

contents 目錄

company milestones	公司里程碑	2
project selection	工程項目例子	3-4
product code guide	產品代號指南	5
cable trunking	電線槽	6-13
cable tray	電纜托盤	14-18
cable ladder	電纜梯架	19-22
cable basket	電線籃	23-26
waterproof trunking	防水線槽	27-29
skirting trunking	牆邊線槽	30-31
floor trunking –types	地槽-款式	32
raised floor trunking	地台線槽	33-38
underfloor trunking	藏地線槽	39-43
flushfloor trunking	平地線槽	44-46
common fitting types	常用槽曲款式	47
cable capacity	電線容量	48

1960

Company founders enter the industry

公司創辦人進軍五金行業

1991

LH is appointed one of the major suppliers to HK government agencies

力雄被列入政府指定供應商之一

2001

LH is awarded ISO 9001 for quality management system

力雄首獲ISO 9001質量管理標準

2015

Hong Kong warehouse moved to Kwai Chung, tripling Hong Kong storage area (~1200sqm)

香港倉搬遷到葵涌, 大大擴充庫存空間

2018

LH is awarded "Caring Company" status, for investment in people, environment, community.

力雄首獲"商界展關懷"公司殊榮

1985

"Lik Hung" brand of cable containment products launched

"力雄牌"線槽疏齒面世

1992

Dongguan factory site established (~6000 sqm)

生產移師東莞工廠

2007

Phase 2 expansion of Dongguan factory site (+~9000sqm)

東莞工廠擴建 9000sqm, 加大生產規模

2017

Phase 3 expansion of Dongguan factory site to increase assembly area (+~1100sqm)

工廠第3期擴展, 增加組裝空間

2018/19

LH is awarded their first patents and design award for new floor service box

力雄新款地台箱榮獲公司第一批專利和獎項

*Care. Commitment. Expertise
for over half a century*

盡心, 承諾, 專業 超過半世紀



Kwai Chung Hospital Phase 2
2021 -



Ocean Park Waterworld
2018 - 19

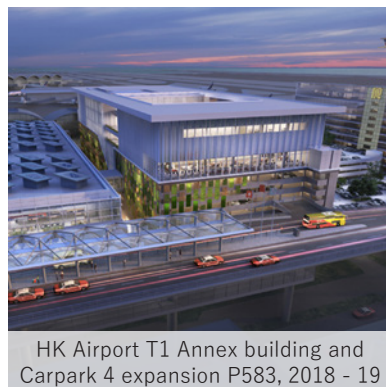

HK Airport T1 Annex building and
Carpark 4 expansion P583, 2018 - 19



M+ Museum
2017 - 2020

Hong Kong
香港



Tuen Mun - Chek Lap Kok Link
2016 - 18

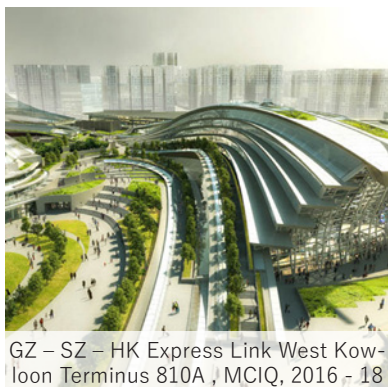

GZ - SZ - HK Express Link West Kowloon
Terminus 810A , MCIQ, 2016 - 18



New World Centre H2 K11 Musea
2016 - 17



HK Disneyland
2012 - 16

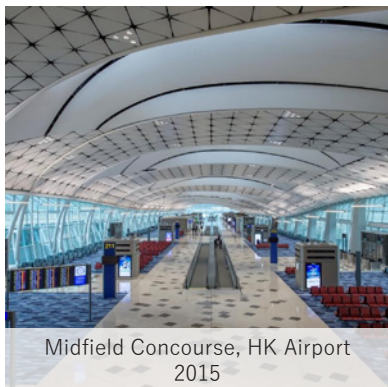

Midfield Concourse, HK Airport
2015



T-Park, Tuen Mun Sludge Treatment
2012 - 13



International Finance Centre, International
Commerce Centre, 2004, 2010



Macau
澳門



Mainland China
中國大陸

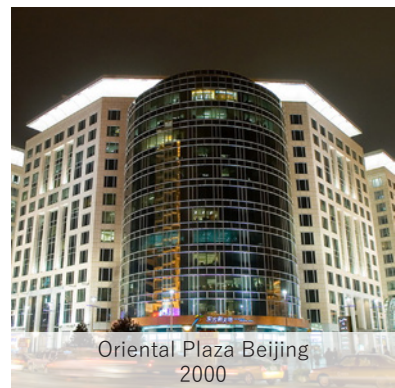

Other references can be found on www.likhung.hk 更多項目可到公司網站瀏覽

Cable trunking, basket, tray, ladder product codes

線槽, 線籃, 托盤, 梯架 產品代號

	PRODUCT TYPE 產品類	DIMENSION 尺寸	FITTINGS 配件/ 曲編號	THICKNESS 厚度	OTHER 其他	
e.g	QT	4X3	.1	T12	H	
TRUNKING 線槽	QT Centre Caption 肚臍蓋	4X3	.1 90°Bend Front opening 正曲	T9 0.9mm	D Double / Multi compartment 孖格 (Trunking only) (只限線槽)	
	CT Clip Fix 彈夾蓋		4" inches wide 闊	.2 90°Bend Internal opening 內曲	T10 1.0mm	
	ST Screw Fix 螺絲蓋		X 3" inches tall 高	.3 Tee Bend 三叉曲	T11 1.12mm	H Hot Dip Galvanized 熱浸鋅
BASKET 線籃	CAB Cable basket 電線籃		.4 90°Bend External opening 外曲	T12 1.2mm T14 1.4mm	P Paint (Epoxy powder) (噴粉)	
	SG Single flange 單邊疏齒	4 4" inches wide 闊	.5 90°Cross Fitting 十字曲	T15 1.5mm		
TRAY 托盤	RG Return flange 勾邊疏齒	X (Standard product height 標準高度)	.6 Reducer fitting 刁士	T16 1.6mm	S 304 Stainless Steel 304 不銹鋼	
	CL Cable ladder 電纜梯架	100 100mm wide 闊 X (Standard product height 標準高度)	.11 A / B / C 135°Bend Front / Internal / External 135°正 / 內 / 外曲	T18 1.8mm T20 2.0mm	X 316 Stainless steel 316 不銹鋼	

Cable Trunking 電線槽

STANDARDS

BS 4678 Part 1 Class 2 & 3 Corrosion Protection, BS1449, BSEN 50085-1,2-1, IEC 61084-1, 2-1, BSEN 10139, EN 10143, BSEN 10149

規格標準

BS 4678 Part 1 Class 2 & 3 抗蝕保護, BS1449, BSEN 50085-1,2-1, IEC 61084-1, 2-1, BSEN 10139, EN 10143, BSEN 10149

TRUNKING COVER TYPE

Centre Caption (QT)
Screw Fix (ST)
Clip Fix (CT)

槽蓋款式

肚臍蓋(QT)
螺絲蓋(ST)
彈夾蓋(CT)

MATERIAL

Galvanised Steel Sheet
Mild Steel
Stainless Steel Sheet SS304 (S), SS316 (X)

原料

鍍鋅鋼板
鋼板
不銹鋼板SS304 (S), SS316 (X)

LENGTH

Standard length of 2.44m,
Other lengths available on request

長度

標準2.44m,
其他長度可按照客需要

THICKNESS

Comply to BS 4678
Other thicknesses can be made
(0.9mm -2.0mm)

厚度

符合BS 4678要求
其他厚度由0.9mm -2.0mm 可按要求生產

FINISHES

Hot Dip Galvanized to BS729, ISO1460, 1461 (H)
Coloured Epoxy Powder Coating / High Grade Outdoor Powder (P)

表面處理

熱浸鋅符合標準BS729, ISO1460, 1461 (H)
顏色聚脂油粉 / 高級戶外粉 (P)

SEPARATE COMPARTMENTS

2 compartment (D), or multi compartment (T) as requested

槽內間格

可按照客人的要求製成二倉式(D), 多倉式(T)

Fittings and accessories meet the same standard and specifications as trunkings
線槽配件的規格及標準完全遵照及配合電線槽而製成

Cable trunking 電線槽

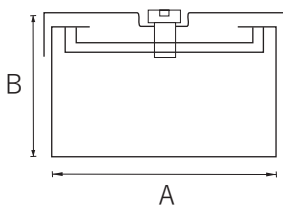
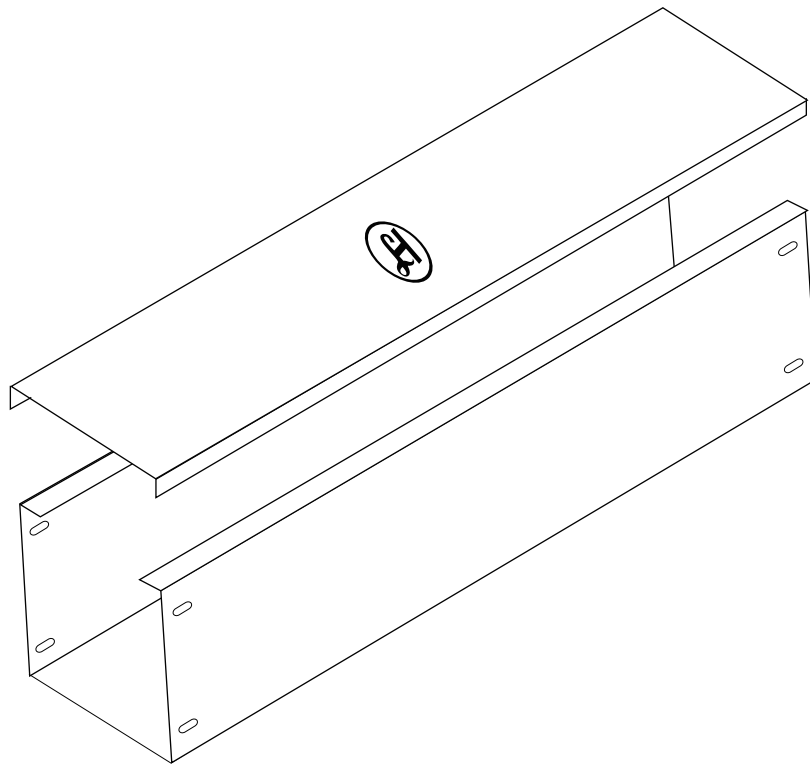

Centre Caption 肚臍蓋型

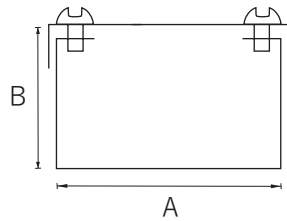

Screw Fix 螺絲蓋型

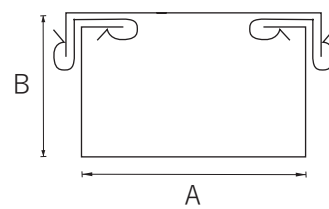

Clip Fix 彈夾蓋型

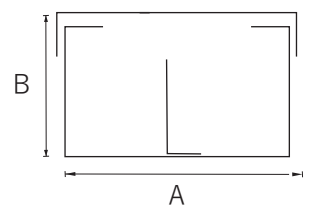

Multi-Compartment 分格式

Cable trunking size 電線槽尺寸 (mm)	Dimension 尺寸 (mm)		Model Number 型號		
	A	B	Centre Caption (QT) 肚臍蓋型	Screw Fix (ST) 螺絲蓋型	Clip Fix (CT) 彈夾蓋型
50 x 50	50	50	QT2X2T10	ST2X2T10	CT2X2T10
75 x 50	75	50	QT3X2T12	ST3X2T12	CT3X2T12
75 x 75	75	75	QT3X3T12	ST3X3T12	CT3X3T12
100 x 75	100	75	QT4X3T12	ST4X3T12	CT4X3T12
100 x 100	100	100	QT4X4T14	ST4X4T14	CT4X4T14
150 x 100	150	100	QT6X4T14	ST6X4T14	CT6X4T14
150 x 150	150	150	QT6X6T16	ST6X6T16	CT6X6T16
200 x 150	200	150	QT8X6T16	ST8X6T16	CT8X6T16
200 x 200	200	200	QT8X8T16	ST8X8T16	CT8X8T16

Other sizes can be custom made
其他尺寸可按客戶要求生產

Cable trunking - Fittings and accessories 電線槽曲及配件

90° Mitre bend 90° 斜角槽曲

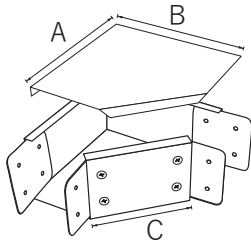

Front opening 正面蓋型

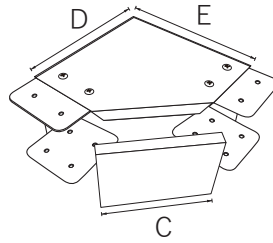

Internal opening 內開蓋型

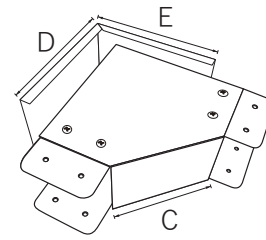

External opening 外開蓋型

Suitable for trunking size 適用線槽尺寸 (mm)	Dimension 尺寸 (mm)					Model: Centre Caption 肚臍蓋型 (QT), Screw Fix 螺絲蓋型 (ST), Clip fix 彈夾蓋型 (CT)		
	A	B	C	D	E	Front opening 正面蓋型	Internal Opening 內開蓋型	External opening 外開蓋型
50 x 50	125	125	106	125	125	QT/ST/CT 2X2.1T10	QT/ST/CT 2X2.2T10	QT/ST/CT 2X2.4BT10
75 x 50	150	150	106	125	125	QT/ST/CT 3X2.1T12	QT/ST/CT 3X2.2T12	QT/ST/CT 3X2.4BT12
75 x 75	150	150	106	150	150	QT/ST/CT 3X3.1T12	QT/ST/CT 3X3.2T12	QT/ST/CT 3X3.4BT12
100 x 75	175	175	106	150	150	QT/ST/CT 4X3.1T12	QT/ST/CT 4X3.2T12	QT/ST/CT 4X3.4BT12
100 x 100	175	175	106	175	175	QT/ST/CT 4X4.1T14	QT/ST/CT 4X4.2T14	QT/ST/CT 4X4.4BT14
150 x 100	225	225	106	175	175	QT/ST/CT 6X4.1T14	QT/ST/CT 6X4.2T14	QT/ST/CT 6X4.4BT14
150 x 150	225	225	106	225	225	QT/ST/CT 6X6.1T16	QT/ST/CT 6X6.2T16	QT/ST/CT 6X6.4BT16
200 x 150	275	275	106	225	225	QT/ST/CT 8X6.1T16	QT/ST/CT 8X6.2T16	QT/ST/CT 8X6.4BT16
200 x 200	275	275	106	275	275	QT/ST/CT 8X8.1T16	QT/ST/CT 8X8.2T16	QT/ST/CT 8X8.4BT16

90° Sharp bend 90° 死角槽曲

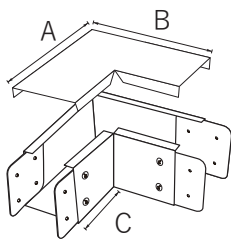

Front opening 正面蓋型

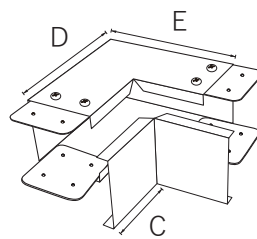

Internal opening 內開蓋型

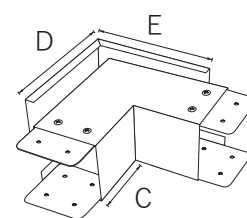

External opening 外開蓋型

Suitable for trunking size 適用線槽尺寸 (mm)	Dimension 尺寸 (mm)					Model: Centre Caption 肚臍蓋型 (QT), Screw Fix 螺絲蓋型 (ST), Clip fix 彈夾蓋型 (CT)		
	A	B	C	D	E	Front opening 正面蓋型	Internal Opening 內開蓋型	External opening 外開蓋型
50 x 50	125	125	75	125	125	QT/ST/CT 2X2.1AT10	QT/ST/CT 2X2.2AT10	QT/ST/CT 2X2.4AT10
75 x 50	150	150	75	125	125	QT/ST/CT 3X2.1AT12	QT/ST/CT 3X2.2AT12	QT/ST/CT 3X2.4AT12
75 x 75	150	150	75	150	150	QT/ST/CT 3X3.1AT12	QT/ST/CT 3X3.2AT12	QT/ST/CT 3X3.4AT12
100 x 75	175	175	75	150	150	QT/ST/CT 4X3.1AT12	QT/ST/CT 4X3.2AT12	QT/ST/CT 4X3.4AT12
100 x 100	175	175	75	175	175	QT/ST/CT 4X4.1AT14	QT/ST/CT 4X4.2AT14	QT/ST/CT 4X4.4AT14
150 x 100	225	225	75	175	175	QT/ST/CT 6X4.1AT14	QT/ST/CT 6X4.2AT14	QT/ST/CT 6X4.4AT14
150 x 150	225	225	75	225	225	QT/ST/CT 6X6.1AT16	QT/ST/CT 6X6.2AT16	QT/ST/CT 6X6.4AT16
200 x 150	275	275	75	225	225	QT/ST/CT 8X6.1AT16	QT/ST/CT 8X6.2AT16	QT/ST/CT 8X6.4AT16
200 x 200	275	275	75	275	275	QT/ST/CT 8X8.1AT16	QT/ST/CT 8X8.2AT16	QT/ST/CT 8X8.4AT16

Cable trunking - Fittings and accessories 電線槽曲及配件

Mitre tee 斜角三叉

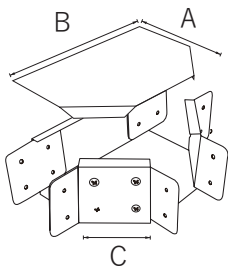

Front opening
正面蓋型

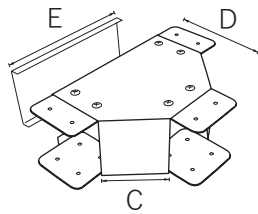

Top opening-Type 1
頂開蓋型-款式1

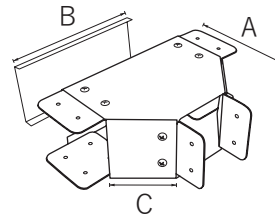

Top opening-Type 2
頂開蓋型-款式2

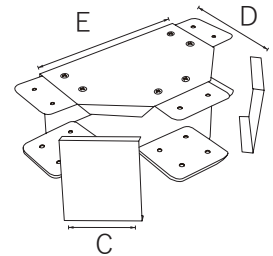

Internal opening
內開蓋型

Suitable for trunking size 適用線槽尺寸 (mm)	Dimension 尺寸 (mm)					Model: Centre Caption 肚臍蓋型 (QT), Screw Fix 螺絲蓋型 (ST), Clip fix 彈夾蓋型 (CT)			
	A	B	C	D	E	Front opening 正面蓋型	Top opening - Type 1 頂開蓋型-款式1	Top opening - Type 2 頂開蓋型-款式2	Internal Opening 內開蓋型
50 x 50	100	150	70	100	150	QT/ST/CT 2X2.3T10	QT/ST/CT 2X2.13B1T10	QT/ST/CT 2X2.13B2T10	QT/ST/CT 2X2.13CDT10
75 x 50	125	175	70	100	150	QT/ST/CT 3X2.3T12	QT/ST/CT 3X2.13B1T12	QT/ST/CT 3X2.13B2T12	QT/ST/CT 3X2.13CDT12
75 x 75	125	175	70	125	175	QT/ST/CT 3X3.3T12	QT/ST/CT 3X3.13B1T12	QT/ST/CT 3X3.13B2T12	QT/ST/CT 3X3.13CDT12
100 x 75	150	200	70	125	175	QT/ST/CT 4X3.3T12	QT/ST/CT 4X3.13B1T12	QT/ST/CT 4X3.13B2T12	QT/ST/CT 4X3.13CDT12
100 x 100	150	200	70	150	200	QT/ST/CT 4X4.3T14	QT/ST/CT 4X4.13B1T14	QT/ST/CT 4X4.13B2T14	QT/ST/CT 4X4.13CDT14
150 x 100	225	300	106	175	250	QT/ST/CT 6X4.3T14	QT/ST/CT 6X4.13B1T14	QT/ST/CT 6X4.13B2T14	QT/ST/CT 6X4.13CDT14
150 x 150	225	300	106	225	300	QT/ST/CT 6X6.3T16	QT/ST/CT 6X6.13B1T16	QT/ST/CT 6X6.13B2T16	QT/ST/CT 6X6.13CDT16
200 x 150	275	350	106	225	300	QT/ST/CT 8X6.3T16	QT/ST/CT 8X6.13B1T16	QT/ST/CT 8X6.13B2T16	QT/ST/CT 8X6.13CDT16
200 x 200	275	350	106	275	350	QT/ST/CT 8X8.3T16	QT/ST/CT 8X8.13B1T16	QT/ST/CT 8X8.13B2T16	QT/ST/CT 8X8.13CDT16

Sharp tee 死角三叉

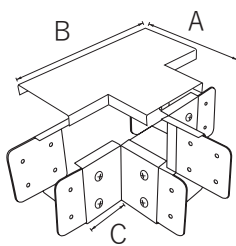

Front opening
正面蓋型

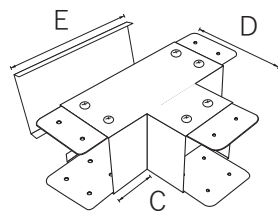

Top opening-Type 1
頂開蓋型-款式1

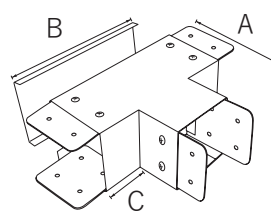

Top opening-Type 2
頂開蓋型-款式2

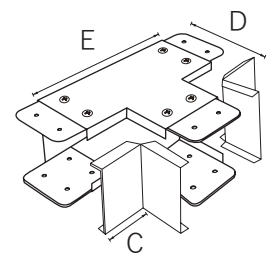

Internal opening
內開蓋型

Suitable for trunking size 適用線槽尺寸 (mm)	Dimension 尺寸 (mm)					Model: Centre Caption 肚臍蓋型 (QT), Screw Fix 螺絲蓋型 (ST), Clip fix 彈夾蓋型 (CT)			
	A	B	C	D	E	Front opening 正面蓋型	Top opening - Type 1 頂開蓋型-款式1	Top opening - Type 2 頂開蓋型-款式2	Internal Opening 內開蓋型
50 x 50	100	150	50	100	150	QT/ST/CT 2X2.3AT10	QT/ST/CT 2X2.13AB1T10	QT/ST/CT 2X2.13AB2T10	QT/ST/CT 2X2.13ACDT10
75 x 50	125	175	50	100	150	QT/ST/CT 3X2.3AT12	QT/ST/CT 3X2.13AB1T12	QT/ST/CT 3X2.13AB2T12	QT/ST/CT 3X2.13ACDT12
75 x 75	125	175	50	125	175	QT/ST/CT 3X3.3AT12	QT/ST/CT 3X3.13AB1T12	QT/ST/CT 3X3.13AB2T12	QT/ST/CT 3X3.13ACDT12
100 x 75	150	200	50	125	175	QT/ST/CT 4X3.3AT12	QT/ST/CT 4X3.13AB1T12	QT/ST/CT 4X3.13AB2T12	QT/ST/CT 4X3.13ACDT12
100 x 100	150	200	50	150	200	QT/ST/CT 4X4.3AT14	QT/ST/CT 4X4.13AB1T14	QT/ST/CT 4X4.13AB2T14	QT/ST/CT 4X4.13ACDT14
150 x 100	225	300	75	175	250	QT/ST/CT 6X4.3AT14	QT/ST/CT 6X4.13AB1T14	QT/ST/CT 6X4.13AB2T14	QT/ST/CT 6X4.13ACDT14
150 x 150	225	300	75	225	300	QT/ST/CT 6X6.3AT16	QT/ST/CT 6X6.13AB1T16	QT/ST/CT 6X6.13AB2T16	QT/ST/CT 6X6.13ACDT16
200 x 150	275	350	75	225	300	QT/ST/CT 8X6.3AT16	QT/ST/CT 8X6.13AB1T16	QT/ST/CT 8X6.13AB2T16	QT/ST/CT 8X6.13ACDT16
200 x 200	275	350	75	275	350	QT/ST/CT 8X8.3AT16	QT/ST/CT 8X8.13AB1T16	QT/ST/CT 8X8.13AB2T16	QT/ST/CT 8X8.13ACDT16

Cable trunking - Fittings and accessories 電線槽曲及配件

135° Bend 135° 斜角槽曲

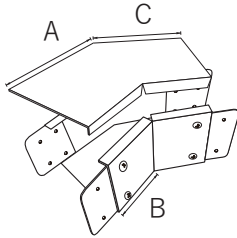

Front opening 正面蓋型

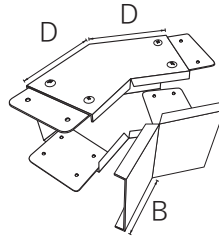

Internal opening 內開蓋型

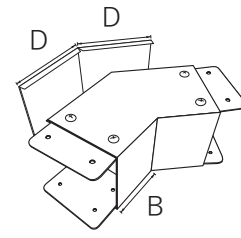

External opening 外開蓋型

Suitable for trunking size 適用線槽尺寸 (mm)	Dimension 尺寸 (mm)				Model: Centre Caption 肚臍蓋型 (QT), Screw Fix 螺絲蓋型 (ST), Clip fix 彈夾蓋型 (CT)		
	A	B	C	D	Front opening 正面蓋型	Internal Opening 內開蓋型	External opening 外開蓋型
50 x 50	95	75	95	95	QT/ST/CT 2X2.11AT10	QT/ST/CT 2X2.11BT10	QT/ST/CT 2X2.11CT10
75 x 50	105	75	105	95	QT/ST/CT 3X2.11AT12	QT/ST/CT 3X2.11BT12	QT/ST/CT 3X2.11CT12
75 x 75	105	75	105	105	QT/ST/CT 3X3.11AT12	QT/ST/CT 3X3.11BT12	QT/ST/CT 3X3.11CT12
100 x 75	116	75	116	105	QT/ST/CT 4X3.11AT12	QT/ST/CT 4X3.11BT12	QT/ST/CT 4X3.11CT12
100 x 100	116	75	116	116	QT/ST/CT 4X4.11AT14	QT/ST/CT 4X4.11BT14	QT/ST/CT 4X4.11CT14
150 x 100	137	75	137	116	QT/ST/CT 6X4.11AT14	QT/ST/CT 6X4.11BT14	QT/ST/CT 6X4.11CT14
150 x 150	137	75	137	137	QT/ST/CT 6X6.11AT16	QT/ST/CT 6X6.11BT16	QT/ST/CT 6X6.11CT16
200 x 150	157	75	157	137	QT/ST/CT 8X6.11AT16	QT/ST/CT 8X6.11BT16	QT/ST/CT 8X6.11CT16
200 x 200	157	75	157	157	QT/ST/CT 8X8.11AT16	QT/ST/CT 8X8.11BT16	QT/ST/CT 8X8.11CT16

90° Mitre Cross 90° 十字槽曲

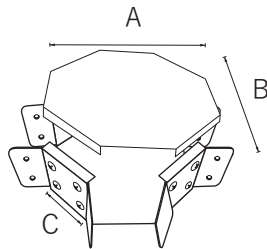

Front opening 正面蓋型

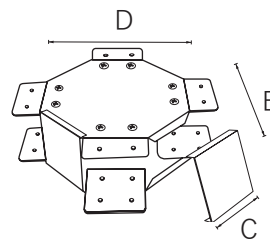

Internal opening 內開蓋型

Suitable for trunking size 適用線槽尺寸 (mm)	Dimension 尺寸 (mm)					Model: Centre Caption 肚臍蓋型 (QT), Screw Fix 螺絲蓋型 (ST), Clip fix 彈夾蓋型 (CT)	
	A	B	C	D	E	Flat Bend 正曲型	Internal Bend 內曲型
50 x 50	150	150	70	150	150	QT/ST/CT 2X2.5T10	QT/ST/CT 2X2.5CDT10
75 x 50	175	175	70	150	150	QT/ST/CT 3X2.5T12	QT/ST/CT 3X2.5CDT12
75 x 75	175	175	70	175	175	QT/ST/CT 3X3.5T12	QT/ST/CT 3X3.5CDT12
100 x 75	200	200	70	175	175	QT/ST/CT 4X3.5T12	QT/ST/CT 4X3.5CDT12
100 x 100	200	200	70	200	200	QT/ST/CT 4X4.5T14	QT/ST/CT 4X4.5CDT14
150 x 100	300	300	106	250	250	QT/ST/CT 6X4.5T14	QT/ST/CT 6X4.5CDT14
150 x 150	300	300	106	300	300	QT/ST/CT 6X6.5T16	QT/ST/CT 6X6.5CDT16
200 x 150	350	350	106	300	300	QT/ST/CT 8X6.5T16	QT/ST/CT 8X6.5CDT16
200 x 200	350	350	106	350	350	QT/ST/CT 8X8.5T16	QT/ST/CT 8X8.5CDT16

Cable trunking - Fittings and accessories 電線槽曲及配件

Flared connector 槽蓋刁士

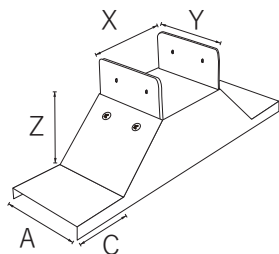

Top opening 喇叭咀

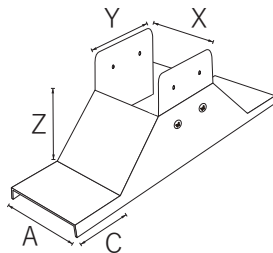

Top opening 90° 槽蓋刁士

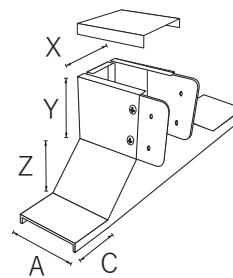

Side opening 扭向槽口短蓋

Suitable for trunking size 適用線槽尺寸 (mm)	Dimension 尺寸 (mm)					Model: Centre Caption 肚臍蓋型 (QT), Screw Fix 螺絲蓋型 (ST), Clip fix 彈夾蓋型 (CT)		
	A	C	X	Y	Z	Top Opening 喇叭咀	Top Opening (90) 槽蓋刁士	Side Opening 扭向槽口短蓋
50 x 50	50	50	50	50	50	QT/ST/CT 2X2.15AT10	QT/ST/CT 2X2.15BT10	QT/ST/CT 2X2.17T10
75 x 50	75	50	75	50	50	QT/ST/CT 3X2.15AT12	QT/ST/CT 3X2.15BT12	QT/ST/CT 3X2.17T12
75 x 75	75	50	75	75	50	QT/ST/CT 3X3.15AT12	QT/ST/CT 3X3.15BT12	QT/ST/CT 3X3.17T12
100 x 75	100	50	100	75	50	QT/ST/CT 4X3.15AT12	QT/ST/CT 4X3.15BT12	QT/ST/CT 4X3.17T12
100 x 100	100	50	100	100	50	QT/ST/CT 4X4.15AT14	QT/ST/CT 4X4.15BT14	QT/ST/CT 4X4.17T14
150 x 100	150	50	150	100	50	QT/ST/CT 6X4.15AT14	QT/ST/CT 6X4.15BT14	QT/ST/CT 6X4.17T14
150 x 150	150	50	150	150	50	QT/ST/CT 6X6.15AT16	QT/ST/CT 6X6.15BT16	QT/ST/CT 6X6.17T16
200 x 150	200	50	200	150	50	QT/ST/CT 8X6.15AT16	QT/ST/CT 8X6.15BT16	QT/ST/CT 8X6.17T16
200 x 200	200	50	200	200	50	QT/ST/CT 8X8.15AT16	QT/ST/CT 8X8.15BT16	QT/ST/CT 8X8.17T16

Reducer 刁士

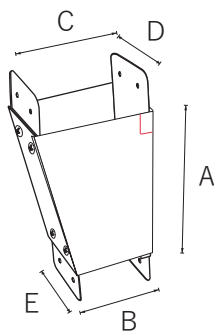

Left 左刁士

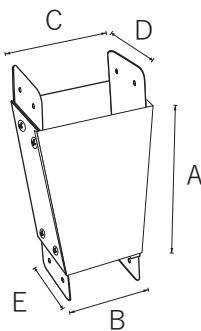

Equal 正刁士

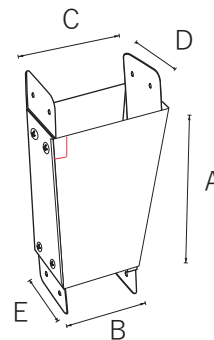

Right 右刁士

Suitable for trunking size 適用線槽尺寸 (mm)	Dimension 尺寸 (mm)					Model: Centre Caption 肚臍蓋型 (QT), Screw Fix 螺絲蓋型 (ST), Clip fix 彈夾蓋型 (CT)
	A	B	C	D	E	
75x75-50x50	150	50	75	75	50	QT/ST/CT3X3.6T12
100x50-50x50	150	50	100	50	50	QT/ST/CT4X2.6T12
100x100-75x75	150	75	100	100	75	QT/ST/CT4X4.6T14
150x100-100x100	200	100	150	100	100	QT/ST/CT6X4.6T14
150x150-100x100	200	100	150	150	100	QT/ST/CT6X6.6T16
200x200 - 150x150	200	150	200	200	150	QT/ST/CT8X8.6T16

Cable trunking - Fittings and accessories 電線槽曲及配件

End cap 槽尾凸

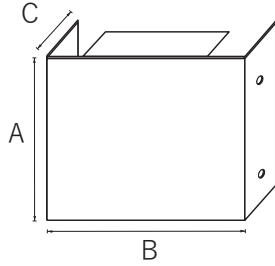

Suitable for trunking size 適用線槽尺寸 (mm)	Dimension 尺寸 (mm)			Model Number 型號
	A	B	C	
50 x 50	48	48	25	ECS2X2
75 x 50	48	73	25	ECS3X2
75 x 75	73	73	25	ECS3X3
100 x 75	73	98	25	ECS4X3
100 x 100	98	98	25	ECS4X4
150 x 100	98	148	25	ECS6X4
150 x 150	148	148	25	ECS6X6
200 x 150	148	198	25	ECS8X6
200 x 200	198	198	25	ECS8X8

Cable support 電線掛片

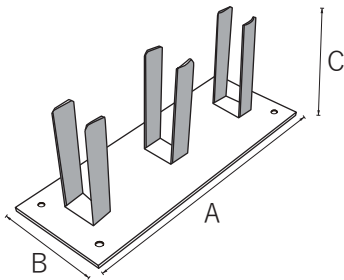

Suitable for trunking size 適用線槽尺寸 (mm)	Dimension 尺寸 (mm)			Model Number 型號
	A	B	C	
50 x 50	250	45	45	CSF2X2
75 x 50	250	70	45	CSF3X2
75 x 75	250	70	70	CSF3X3
100 x 75	250	95	70	CSF4X3
100 x 100	250	95	95	CSF4X4
150 x 100	250	145	95	CSF6X4
150 x 150	250	145	145	CSF6X6
200 x 150	250	195	145	CSF8X6
200 x 200	250	195	195	CSF8X8

Flange 槽吊咀

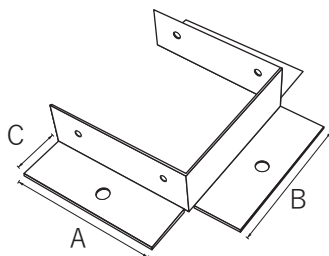

Suitable for trunking size 適用線槽尺寸 (mm)	Dimension 尺寸 (mm)			Model Number 型號
	A	B	C	
50 x 50	48	48	25	FF2X2
75 x 50	48	73	25	FF3X2
75 x 75	73	73	25	FF3X3
100 x 75	73	98	25	FF4X3
100 x 100	98	98	25	FF4X4
150 x 100	98	148	25	FF6X4
150 x 150	148	148	25	FF6X6
200 x 150	148	198	25	FF8X6
200 x 200	198	198	25	FF8X8

Cable trunking - Fittings and accessories 電線槽曲及配件

Trunking connector 槽駁片

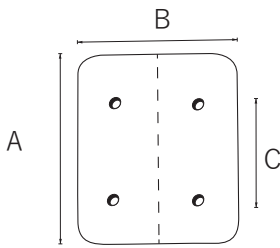

Couple connector 對裝槽駁片

Suitable for trunking size 適用線槽尺寸 (mm)	Dimension 尺寸 (mm)			Model Number 型號 Couple Connector 對裝槽駁片
	A	B	C	
50 x 50	40	70	-	CPF2
75 x 50	40	70	-	CPF2
75 x 75	68	68	35	CPF3
100 x 75	68	68	35	CPF3
100 x 100	92	70	60	CPF4
150 x 100	92	70	60	CPF4
150 x 150	143	70	111	CPF6
200 x 150	143	70	111	CPF6
200 x 200	194	70	160	CPF8

Trunking connector 槽駁片

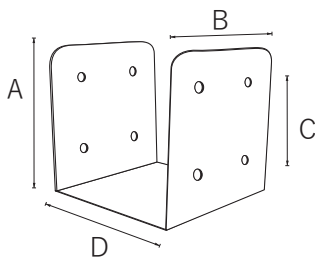

U-shaped connector U 型槽駁片

Suitable for trunking size 適用線槽尺寸 (mm)	Dimension 尺寸 (mm)				Model Number 型號 U-shaped Connector U 型槽駁片
	A	B	C	D	
50 x 50	45	70	-	48	CPUF2X2
75 x 50	45	70	-	73	CPUF3X2
75 x 75	68	68	35	73	CPUF3X3
100 x 75	68	68	35	98	CPUF4X3
100 x 100	95	70	60	98	CPUF4X4
150 x 100	95	70	60	148	CPUF6X4
150 x 150	145	70	111	148	CPUF6X6
200 x 150	145	70	111	198	CPUF8X6
200 x 200	195	70	160	198	CPUF8X8

Copper earth links 銅水線片

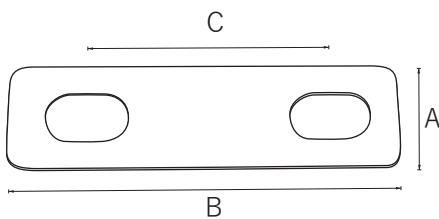

For project type 用於工程種類	Dimension 尺寸 (mm)				Model Number 型號
	Thickness 厚度 mm	A	B	C	
Business Project 一般商用電線槽	0.6	14	48	35	EL75
Architectural Services Department project 建築署用電線槽	1	14	57	35	EL100
Housing Authority Project 房屋署用電線槽	2	12	57	35	EL120
MTRC 地鐵	3	25	58	35	EL150

Cable Tray 電纜托盤

STANDARDS

BS1449, BSEN 10139,
BSEN 10149, IEC61537

規格標準

BS1449, BSEN 10139,
BSEN 10149, IEC61537

FLANGE TYPE

Single Flange (SG)
Return Flange (RG)

摺邊款式

單摺邊 (SG)
雙/勾摺邊 (RG)

FLANGE HEIGHT

Complies with HK government project specifications
Other heights can be produced as needed

邊高

符合香港政府有關部門要求
其他高度可按要求製成

TRAY END STYLE

With / Without built-in
connector

茜身款

茜身連駁款
普通平邊款

MATERIAL

Galvanised Steel Sheet
Mild Steel
Stainless Steel Sheet SS304 (S) /
SS316 (X)

原料

鍍鋅鋼板
鋼板
不銹鋼板SS304 (S),
SS316 (X)

LENGTH

Standard length of 2.44m,
other lengths available on request

長度

標準2.44m,
其他長度可按照客需要

THICKNESS

Complies with HK government project specifications
Other thicknesses can be produced as needed

厚度

符合香港政府有關部門要求
其他厚度可按要求製成

FINISHES

Hot Dip Galvanised to BS729, ISO 1460, 1461
(H)
Coloured Epoxy Powder Coating / High Grade
Outdoor Powder (P)

表面處理

熱浸鋅符合標準BS729, ISO1460, 1461 (H)
顏色聚脂油粉 / 高級戶外粉 (P)

Fittings and accessories meet the same standard and specifications as the trays
配件的規格及標準完全遵照及配合電纜托盤而製成

Cable tray 電纜托盤

Single Flange Type 單摺邊式

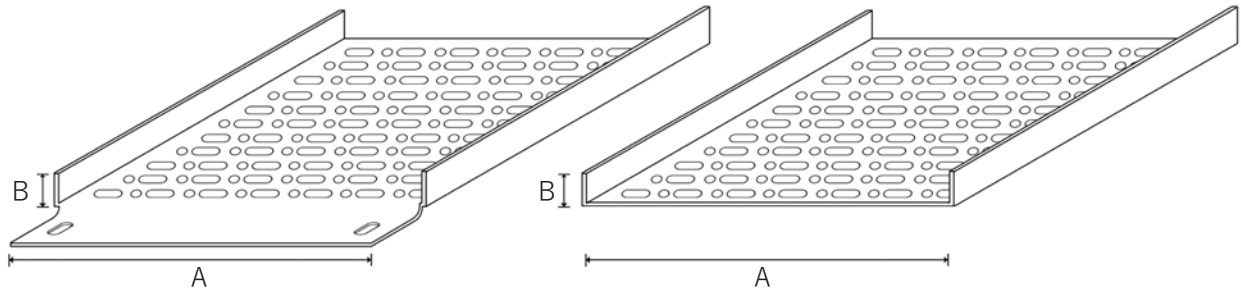

With built-in connector 茜身連駁款

Without built-in connector 普通平邊款

Cable Tray size 電纜托盤 (mm)	Dimension 尺寸 (mm)		Model number 型號			
	A	B	Galvanised Steel 鍍鋅鋼	Hot-dipped Galvanised 熱浸鋅	Stainless Steel SS304 不銹鋼 SS304	Stainless Steel 316 不銹鋼 SS316
50	50	13	SG2T12	SG2T12H	SG2T12S	SG2T12X
75	75	13	SG3T12	SG3T12H	SG3T12S	SG3T12X
100	100	13	SG4T12	SG4T12H	SG4T12S	SG4T12X
150	150	13	SG6T12	SG6T12H	SG6T12S	SG6T12X
200	200	13	SG8T15	SG8T16H	SG8T15S	SG8T15X
300	300	20	SG12T15	SG12T16H	SG12T15S	SG12T15X
400	400	20	SG16T15	SG16T16H	SG16T15S	SG16T15X
500	500	20	SG20T20	SG20T20H	SG20T15S	SG20T15X
600	600	20	SG24T20	SG24T20H	SG24T15S	SG24T15X
700	700	20	SG28T20	SG28T20H	SG28T15S	SG28T15X
800	800	20	SG32T20	SG32T20H	SG32T15S	SG32T15X
900	900	20	SG36T20	SG36T20H	SG36T15S	SG36T15X

Return Flange Type 勾摺邊式

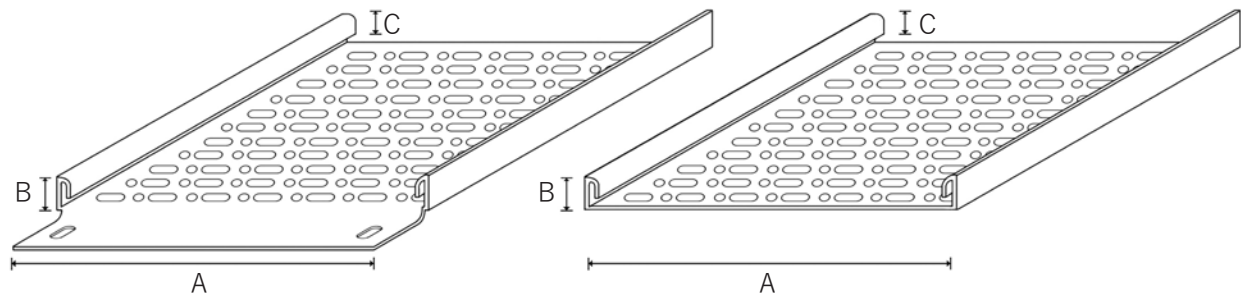

With built-in connector 茜身連駁款

Without built-in connector 普通平邊款

Cable Tray size 電纜托盤 (mm)	Dimension 尺寸 (mm)			Model number 型號			
	A	B	C	Galvanised Steel 鍍鋅鋼	Hot-dipped Galvanised 熱浸鋅	Stainless Steel SS304 不銹鋼 SS304	Stainless Steel 316 不銹鋼 SS316
50	50	20	13	RG2T12	RG2T12H	RG2T12S	RG2T12X
75	75	20	13	RG3T12	RG3T12H	RG3T12S	RG3T12X
100	100	20	13	RG4T12	RG4T12H	RG4T12S	RG4T12X
150	150	20	13	RG6T12	RG6T12H	RG6T12S	RG6T12X
200	200	20	13	RG8T15	RG8T16H	RG8T15S	RG8T15X
300	300	20	13	RG12T15	RG12T16H	RG12T15S	RG12T15X
400	400	20	13	RG16T15	RG16T16H	RG16T15S	RG16T15X
500	500	20	13	RG20T20	RG20T20H	RG20T15S	RG20T15X
600	600	20	13	RG24T20	RG24T20H	RG24T15S	RG24T15X
700	700	20	13	RG28T20	RG28T20H	RG28T15S	RG28T15X
800	800	20	13	RG32T20	RG32T20H	RG32T15S	RG32T15X
900	900	20	13	RG36T20	RG36T20H	RG36T15S	RG36T15X

Other sizes can be custom made 其他尺寸可按客戶要求生產

Cable tray - Fittings and accessories 托盤曲及配件

90° Mitre bend 90° 斜角茜曲

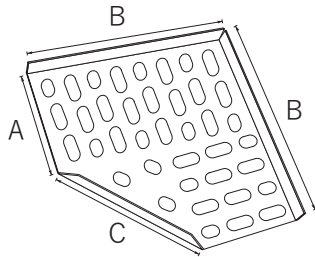

Flat Bend 正曲型

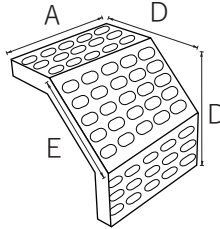

Internal Bend 內曲型

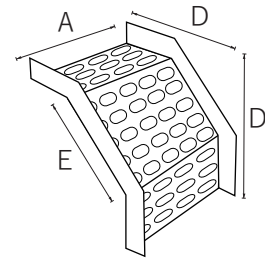

External Bend 外曲型

Suitable for tray size 適用電纜托盤尺寸 (mm)	Dimension 尺寸 (mm)					Model: Single Flange 單摺邊式 (SG), Return Flange 勾摺邊式 (RG)		
	A	B	C	D	E	Flat Bend 正曲型	Internal Bend 內曲型	External Bend 外曲型
50	50	125	106	150	106	SG/RG2.1T12H	SG/RG2.2T12H	SG/RG2.4BT12H
75	75	150	106	150	106	SG/RG3.1T12H	SG/RG3.2T12H	SG/RG3.4BT12H
100	100	175	106	150	106	SG/RG4.1T12H	SG/RG4.2T12H	SG/RG4.4BT12H
150	150	225	106	150	106	SG/RG6.1T12H	SG/RG6.2T12H	SG/RG6.4BT12H
200	200	300	141	175	106	SG/RG8.1T16H	SG/RG8.2T16H	SG/RG8.4BT16H
300	300	400	141	225	106	SG/RG12.1T16H	SG/RG12.2T16H	SG/RG12.4BT16H
400	400	525	177	275	106	SG/RG16.1T16H	SG/RG16.2T16H	SG/RG16.4BT16H
500	500	625	177	275	106	SG/RG20.1T20H	SG/RG20.2T20H	SG/RG20.4BT20H
600	600	750	212	325	106	SG/RG24.1T20H	SG/RG24.2T20H	SG/RG24.4BT20H
700	700	850	212	325	106	SG/RG28.1T20H	SG/RG28.2T20H	SG/RG28.4BT20H
800	800	950	212	325	106	SG/RG32.1T20H	SG/RG32.2T20H	SG/RG32.4BT20H
900	900	1050	212	325	106	SG/RG36.1T20H	SG/RG36.2T20H	SG/RG36.4BT20H

135° Mitre bend 135° 斜角茜曲

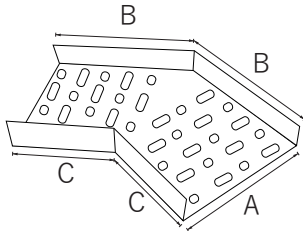

Flat Bend 正曲型

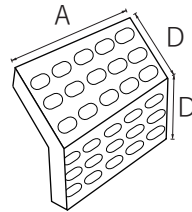

Internal Bend 內曲型

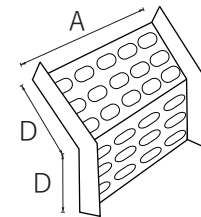

External Bend 外曲型

Suitable for tray size 適用電纜托盤尺寸 (mm)	Dimension 尺寸 (mm)				Model: Single Flange 單摺邊式 (SG), Return Flange 勾摺邊式 (RG)		
	A	B	C	D	Flat Bend 正曲型	Internal Bend 內曲型	External Bend 外曲型
50	50	95	75	75	SG/RG2.11AT12H	SG/RG2.11BT12H	SG/RG2.11CT12H
75	75	106	75	75	SG/RG3.11AT12H	SG/RG3.11BT12H	SG/RG3.11CT12H
100	100	116	75	75	SG/RG4.11AT12H	SG/RG4.11BT12H	SG/RG4.11CT12H
150	150	137	75	75	SG/RG6.11AT12H	SG/RG6.11BT12H	SG/RG6.11CT12H
200	200	158	75	75	SG/RG8.11AT16H	SG/RG8.11BT16H	SG/RG8.11CT16H
300	300	224	100	100	SG/RG12.11AT16H	SG/RG12.11BT16H	SG/RG12.11CT16H
400	400	366	200	200	SG/RG16.11AT16H	SG/RG16.11BT16H	SG/RG16.11CT16H
500	500	407	200	200	SG/RG20.11AT20H	SG/RG20.11BT20H	SG/RG20.11CT20H
600	600	548	300	300	SG/RG24.11AT20H	SG/RG24.11BT20H	SG/RG24.11CT20H
700	700	590	300	300	SG/RG28.11AT20H	SG/RG28.11BT20H	SG/RG28.11CT20H
800	800	631	300	300	SG/RG32.11AT20H	SG/RG32.11BT20H	SG/RG32.11CT20H
900	900	673	300	300	SG/RG36.11AT20H	SG/RG36.11BT20H	SG/RG36.11CT20H

Cable tray - Fittings and accessories 托盤曲及配件

Mitre tee 斜角三叉

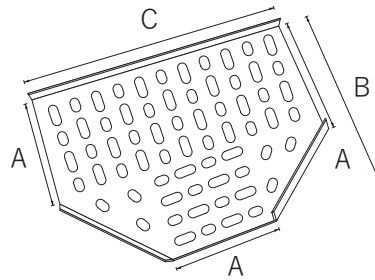

Suitable for tray size 適用電纜托盤尺寸 (mm)	Dimension 尺寸 (mm)			Model: Single Flange 單摺邊式 (SG), Return Flange 勾摺邊式 (RG)
	A	B	C	
50	50	125	200	SG/RG2.3T12H
75	75	150	225	SG/RG3.3T12H
100	100	175	250	SG/RG4.3T12H
150	150	225	300	SG/RG6.3T12H
200	200	300	400	SG/RG8.3T16H
300	300	400	500	SG/RG12.3T16H
400	400	525	650	SG/RG16.3T16H
500	500	625	750	SG/RG20.3T20H
600	600	750	900	SG/RG24.3T20H
700	700	850	1000	SG/RG28.3T20H
800	800	950	1100	SG/RG32.3T20H
900	900	1050	1200	SG/RG36.3T20H

Mitre Cross 十字曲

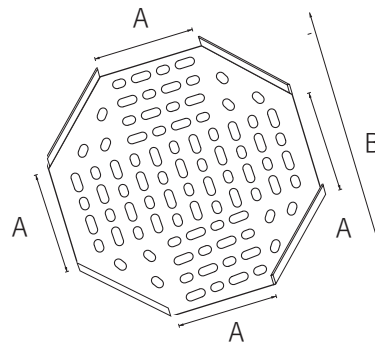

Suitable for tray size 適用電纜托盤尺寸 (mm)	Dimension 尺寸 (mm)		Model: Single Flange 單摺邊式 (SG), Return Flange 勾摺邊式 (RG)
	A	B	
50	50	200	SG/RG2.5T12H
75	75	225	SG/RG3.5T12H
100	100	250	SG/RG4.5T12H
150	150	300	SG/RG6.5T12H
200	200	400	SG/RG8.5T16H
300	300	500	SG/RG12.5T16H
400	400	650	SG/RG16.5T16H
500	500	750	SG/RG20.5T20H
600	600	900	SG/RG24.5T20H
700	700	1000	SG/RG28.5T20H
800	800	1100	SG/RG32.5T20H
900	900	1200	SG/RG36.5T20H

Cable tray - Fittings and accessories 托盤曲及配件

Reducer 刁士

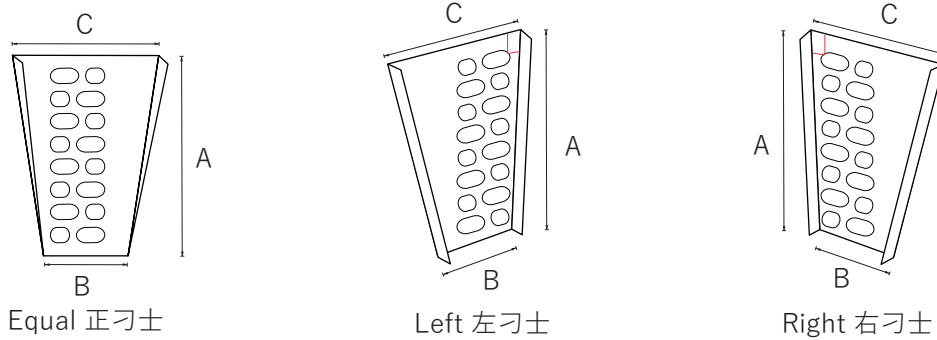

Suitable for tray size 適用電纜托盤尺寸 (mm)	Dimension 尺寸 (mm)			Model: Single Flange 單摺邊式 (SG), Return Flange 勾摺邊式 (RG)
	A	B	C	
75 - 50	150	50	75	SG/RG3.6T12H
100 - 75	150	75	100	SG/RG4.6T12H
150 - 100	200	100	150	SG/RG6.6T12H
150 - 75	200	75	150	SG/RG6.6T12H
200 - 150	200	150	200	SG/RG8.6T16H
200 - 100	200	100	200	SG/RG8.6T16H
300 - 200	300	200	300	SG/RG12.6T16H
300 - 150	300	150	300	SG/RG12.6T16H
400 - 300	400	300	400	SG/RG16.6T16H
600 - 400	500	400	600	SG/RG24.6T20H

Cable tray connector 齒駁片

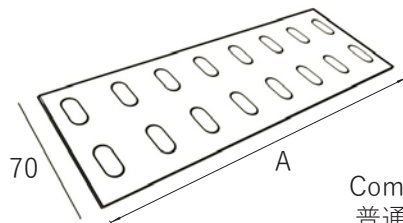

Common Type
普通款 (SGC)

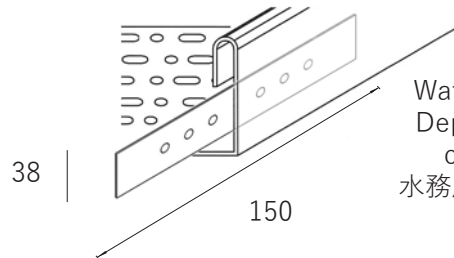

Water Services
Dept. tray side
connector
水務處規格齒旁駁
(RGTZ)

Cable Tray size 電纜托盤 (mm)	Dimension 尺寸 (mm) A	Model number 型號			
		Galvanised Steel 鍍鋅鋼	Hot-dipped Galvanised 熱浸鋅	Stainless Steel SS304 不銹鋼 SS304	Stainless Steel 316 不銹鋼 SS316
50	40	SGC2	SGC2H	SGC2S	SGC2X
75	65	SGC3	SGC3H	SGC3S	SGC3X
100	90	SGC4	SGC4H	SGC4S	SGC4X
150	140	SGC6	SGC6H	SGC6S	SGC6X
200	190	SGC8	SGC8H	SGC8S	SGC8X
300	290	SGC12	SGC12H	SGC12S	SGC12X
400	390	SGC16	SGC16H	SGC16S	SGC16X
500	490	SGC20	SGC20H	SGC20S	SGC20X
600	590	SGC24	SGC24H	SGC24S	SGC24X
900	890	SGC36	SGC36H	SGC36S	SGC36X
-	150 x 38	RGTZ	RGTZH	RGTZS	RGTZX

Cable Ladder 電纜梯架

STANDARDS

BS1449, BSEN 10139,
BSEN 10149, IEC61537

規格標準

BS1449, BSEN 10139,
BSEN 10149, IEC61537

RUNG SPACING

300mm

梯格距離

300mm

MATERIAL

Galvanised Steel Sheet
Mild Steel
Stainless Steel Sheet SS304 (S) /
SS316 (X)

原料

鍍鋅鋼板
鋼板
不銹鋼板SS304 (S), SS316 (X)

LENGTH

Standard length of 2.44m,
other lengths available on request

長度

標準2.44m,
其他長度可按照客需要

THICKNESS

2mm
Other thicknesses under 2mm can be pro-
duced as needed

厚度

2mm
其他厚度(2mm 以下) 可按要求製成

FINISHES

Hot Dip Galvanised to BS729, ISO 1460, 1461
(H)
Coloured Epoxy Powder Coating / High Grade
Outdoor Powder (P)

表面處理

熱浸鋅符合標準BS729, ISO1460, 1461 (H)
顏色聚脂油粉 / 高級戶外粉 (P)

Fittings and accessories meet the same standard and
specifications as the ladders
配件的規格及標準完全遵照及配合梯架而製成

Cable Ladder and Accessories 電纜梯架及配件

Cable Ladder 電纜梯架

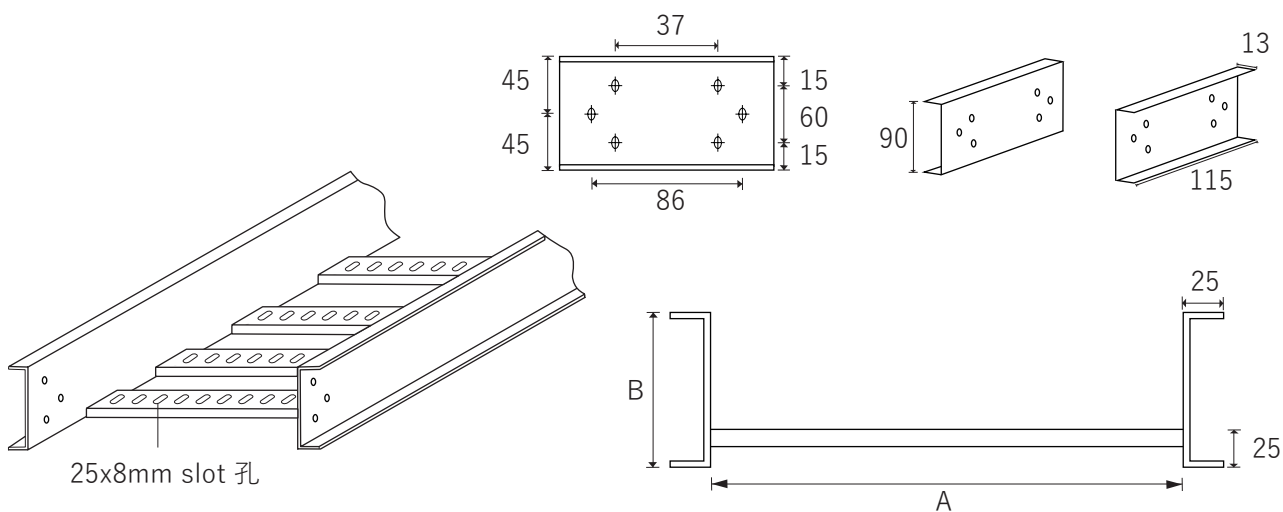

Cable Ladder Size 電纜梯架尺寸 (mm)	Dimension 尺寸 (mm)		Model Number 型號
	A	B	
150	150	100	CL150T20H
300	300	100	CL300T20H
450	450	100	CL450T20H
600	600	100	CL600T20H
900	900	100	CL900T20H
1000	1000	100	CL1000T20H

90° Mitre bend 90° 斜角曲

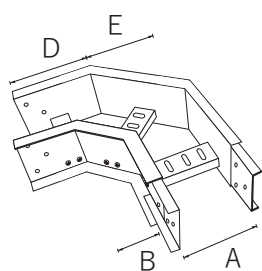

Flat Bend 正曲型

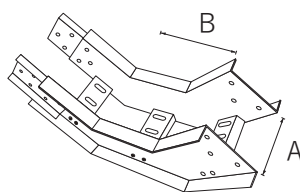

Internal Bend 內曲型

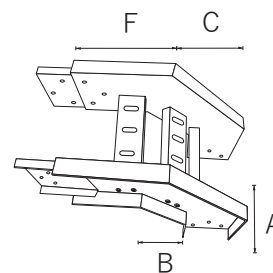

External Bend 外曲型

Suitable for Ladder size 適用電纜梯架尺寸 (mm)	Dimension 尺寸 (mm)						Model Number 型號		
	A	B	C	D	E	F	Flat Bend 正曲型	Internal Bend 內曲型	External Bend 外曲型
150	150	78	136	172	164	150	CL150.1T20H	CL150.2T20H	CL150.4BT20H
300	300	78	136	234	252	150	CL300.1T20H	CL300.2T20H	CL300.4BT20H
450	450	78	136	296	340	150	CL450.1T20H	CL450.2T20H	CL450.4BT20H
600	600	78	136	359	427	150	CL600.1T20H	CL600.2T20H	CL600.4BT20H
900	900	78	136	483	603	150	CL900.1T20H	CL900.2T20H	CL900.4BT20H
1000	1000	78	136	524	662	150	CL1000.1T20H	CL1000.2T20H	CL1000.4BT20H

Other sizes can be custom made
其他尺寸可按客戶要求生產

Cable Ladder and Accessories 電纜梯架及配件

135° Mitre bend 135° 斜角曲

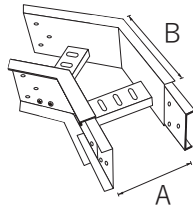

Flat Bend 正曲型

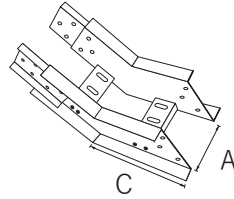

Internal Bend 內曲型

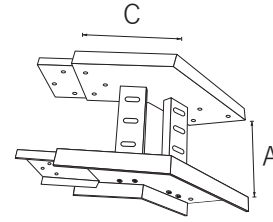

External Bend 外曲型

Suitable for Ladder size 適用電線梯架尺寸 (mm)	Dimension 尺寸 (mm)			Model number 型號		
	A	B	C	Flat Bend 正曲型	Internal Bend 內曲型	External Bend 外曲型
150	150	172	150	CL150.11AT20H	CL150.11BT20H	CL150.11CT20H
300	300	234	150	CL300.11AT20H	CL300.11BT20H	CL300.11CT20H
450	450	296	150	CL450.11AT20H	CL450.11BT20H	CL450.11CT20H
600	600	359	150	CL600.11AT20H	CL600.11BT20H	CL600.11CT20H
900	900	483	150	CL900.11AT20H	CL900.11BT20H	CL900.11CT20H
1000	1000	524	150	CL1000.11AT20H	CL1000.11BT20H	CL1000.11CT20H

Mitre tee 斜角三叉

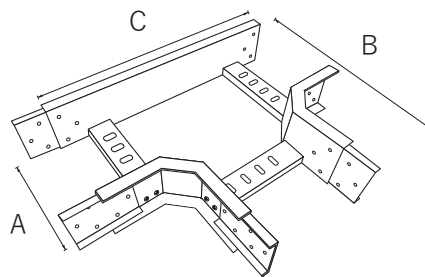

Suitable for Ladder size 適用電線梯架尺寸 (mm)	Dimension 尺寸 (mm)			Model number 型號
	A	B	C	
150	150	310	470	CL150.3T20H
300	300	460	620	CL300.3T20H
450	450	610	770	CL450.3T20H
600	600	760	920	CL600.3T20H
900	900	1060	1220	CL900.3T20H
1000	1000	1160	1320	CL1000.3T20H

Cable Ladder and Accessories 電纜梯架及配件

Mitre Cross 十字曲

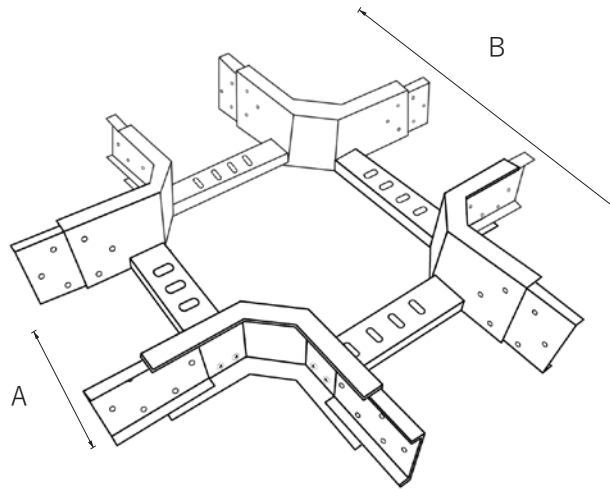

Suitable for Ladder size 適用電線梯架尺寸 (mm)	Dimension 尺寸 (mm)		Model Number 型號
	A	B	
150	150	470	CL150.5T20H
300	300	620	CL300.5T20H
450	450	770	CL450.5T20H
600	600	920	CL600.5T20H
900	900	1220	CL900.5T20H
1000	1000	1320	CL1000.5T20H

Reducer 刁士

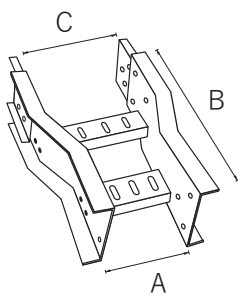

Equal 正刁士

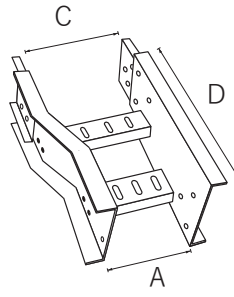

Left 左刁士

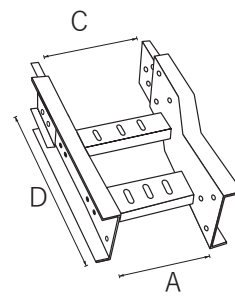

Right 右刁士

Suitable for Ladder size 適用電線梯架尺寸 (mm)	Dimension 尺寸 (mm)				Model Number 型號
	A	B	C	D	
300 - 150	150	295	300	370	CL300.6T20H
450 - 300	300	295	450	370	CL450.6T20H
600 - 450	450	295	600	370	CL600.6T20H
900 - 600	600	370	900	520	CL900.6T20H
1200 - 900	900	370	1200	520	CL1200.6T20H

Cable Basket 電線籃

MATERIAL

50 x 50mm Mild Steel wire grid
Stainless Steel wire grid SS304 (S),
SS316 (X)

原料

50 x 50mm 鋼枝網
不銹鋼網 SS304 (S), SS316 (X)

LENGTH

2.12m
Other lengths available on request

長度

標準2.12m,
其他長度可按照客需要

HEIGHT

50mm, 100mm
Other heights can be made to order

高度

50mm, 100mm
其他高度可按照客需要

THICKNESS

4mm diameter rods
Other diameter rods can be used

厚度

4mm 直徑圓枝
其他直徑可以按客戶要求生產

FINISHES

Electro Zinc Plated to IEC 61537:2006
Hot Dip Galvanised to BS729, ISO 1460, 1461
(H)
Coloured Epoxy Powder Coating / High Grade
Outdoor Powder (P)

表面處理

冷電度鋅 IEC61537 : 2006
熱浸鋅符合標準 BS729, ISO1460, 1461 (H)
顏色聚脂油粉 / 高級戶外粉 (P)

Fittings and accessories meet the same standard and specifications as the baskets
配件的規格及標準完全遵照及配合線籃而製成

Cable Basket 電線籃

Cable Basket, Straight Length 電線籃,直身

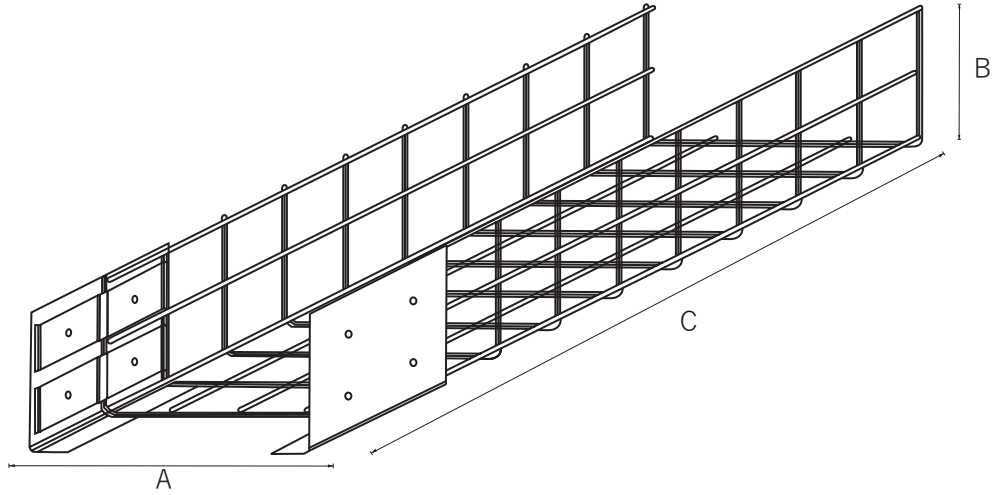

Cable Basket Size 電線籃尺寸 (mm)	Dimension 尺寸 (mm)			Model Number 型號
	A	B	C	
100	100	100	2122	CAB4X4
150	150	100	2122	CAB6X4
300	300	100	2122	CAB12X4
450	450	100	2122	CAB18X4
600	600	100	2122	CAB24X4
900	900	100	2122	CAB36X4

Other sizes can be custom made
其他尺寸可按客戶要求生產

Cable Basket and Accessories 電線籃及配件

90° Bend 籃曲

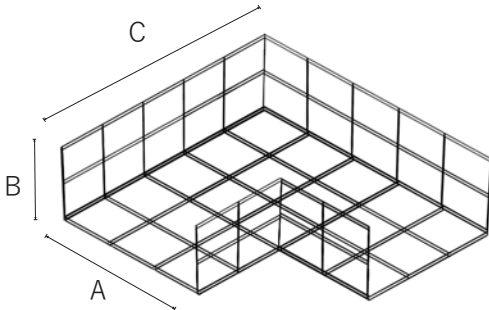

Suitable for basket size 適用電線籃尺寸 (mm)	Dimension 尺寸 (mm)			Model Number 型號
	A	B	C	
100	100	100	200	CAB4X4.1
150	150	100	250	CAB6X4.1
300	300	100	400	CAB12X4.1
450	450	100	550	CAB18X4.1
600	600	100	700	CAB24X4.1
900	900	100	1000	CAB36X4.1

Tee 三叉

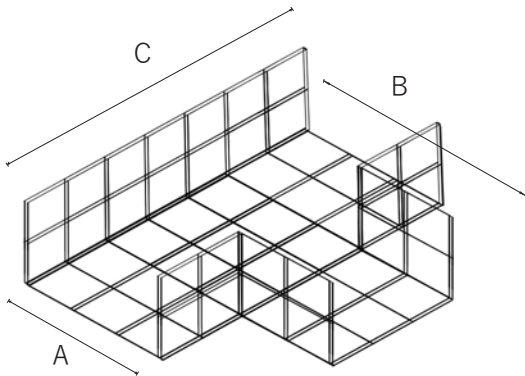

Suitable for basket size 適用電線籃尺寸 (mm)	Dimension 尺寸 (mm)			Model Number 型號
	A	B	C	
100	100	200	300	CAB4X4.3
150	150	250	350	CAB6X4.3
300	300	400	500	CAB12X4.3
450	450	550	650	CAB18X4.3
600	600	700	800	CAB24X4.3
900	900	1000	1100	CAB36X4.3

Connecting plates 旁駁

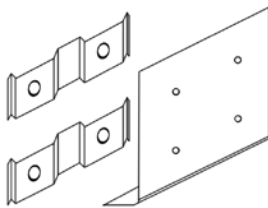

Connecting plates for Basket height (mm) 駁片高度	Model Number 型號 (per pair 每對)
50	CABB1
100	CABB2

Cable Basket and Accessories 電線籃及配件

Fast, Flexible: Self-Assembly Bends 快捷, 靈活: 自組件線籃曲

90° Bend 籃曲

Tee 三叉

L-shaped connector L 型旁駁

CABB4.L (100mm tall 高)
CABB2.L (50mm tall 高)

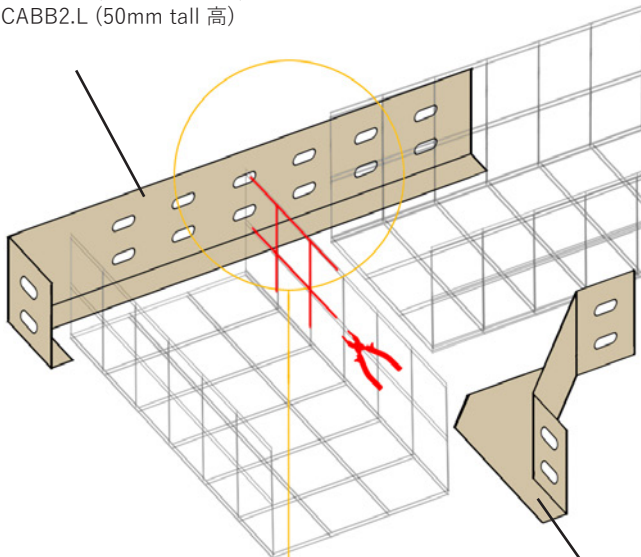

Angle connector 斜邊旁駁

CABB4.G (100mm tall 高)
CABB2.G (50mm tall 高)

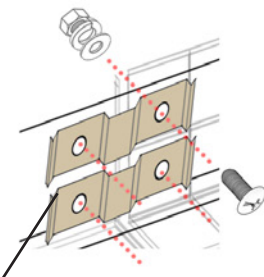

Double-hole flat connector 雙孔波浪型駁片 CABB5GC2

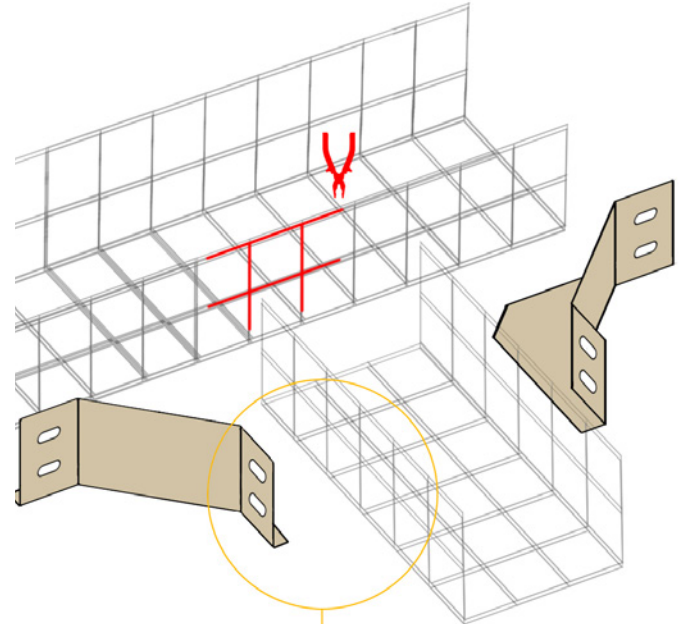

Screw set 螺絲, 絲母, 平介, 彈介 CABB7AS

Single-hole flat connector 單孔波浪型駁片 CABB5GC1

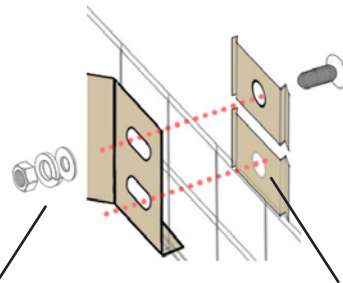

Bend type (Set) / Model number 曲款 (套裝) / 型號	Part quantities (each set) 配件數量 (每套裝)					
	L - shaped connector L 型旁駁	Angle connector 斜邊旁駁	Double-hole flat connector 雙孔波浪型駁片	Single-hole flat connector 單孔波浪型駁片	Screw set (screw, nut, flat and spring washer) 螺絲, 絲母, 平介, 彈介	
90 degree bend (100mm tall) 90度曲 100mm高	CABB4.1	1	1	2	6	10
90 degree bend (50mm tall) 90度曲 50mm高	CABB2.1	1	1	1	3	5
Tee bend (100mm tall) 三叉曲 100mm高	CABB4.3	0	2	0	8	8
Tee bend (50mm tall) 三叉曲 50mm高	CABB2.3	0	2	0	4	4

Waterproof Trunking 防水線槽

STANDARDS

BS 4678 Part 1 Class 2 & 3 Corrosion Protection, BS1449, BSEN 50085-1,2-1, IEC 61084-1,2-1, BSEN 10139, EN 10143, BSEN 10149, IPX4 to IEC60529:2001

規格標準

BS 4678 Part 1 Class 2 & 3 抗蝕保護, BS1449, BSEN 50085-1,2-1, IEC 61084-1,2-1, BSEN 10139, EN 10143, BSEN 10149, IPX4 to IEC60529:2001

TRUNKING COVER TYPE

Screw fix with rubber gasket between trunking and cover

槽蓋款式

螺絲蓋, 槽邊有防水膠邊

MATERIAL

Galvanised Steel Sheet
Mild Steel
Stainless Steel Sheet SS304 (S), SS316 (X)

原料

鍍鋅鋼板
鋼板
不銹鋼板SS304 (S), SS316 (X)

LENGTH

Standard length of 2.44m
Other lengths available on request

長度

標準2.44m,
其他長度可按照客需要

THICKNESS

Comply to BS 4678
Other thicknesses can be made
(0.9mm -2.0mm)

厚度

符合BS 4678要求
其他厚度由0.9mm -2.0mm 可按要求生產

FINISHES

Hot Dip Galvanized to BS729, ISO1460, 1461 (H)
Coloured Epoxy Powder Coating / High Grade Outdoor Powder (P)

表面處理

熱浸鋅符合標準BS729, ISO1460, 1461 (H)
顏色聚脂油粉 / 高級戶外粉 (P)

SEPARATE COMPARTMENTS

2 compartment (D), or multi compartment (T) as requested

槽內間格

可按照客人的要求製成二倉式(D), 多倉式(T)

Fittings and accessories meet the same standard and specifications as trunkings
線槽配件的規格及標準完全遵照及配合電線槽而製成

Waterproof Trunking 防水線槽

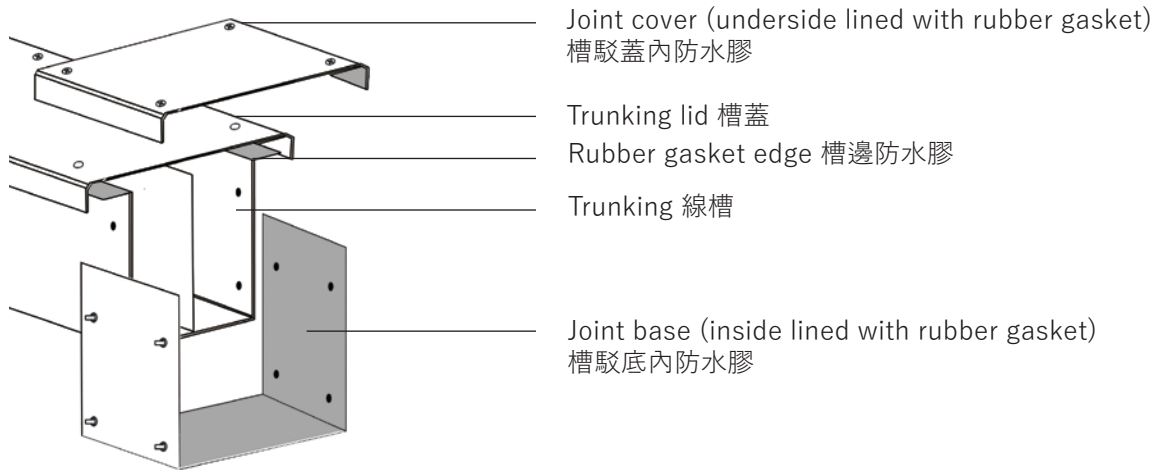
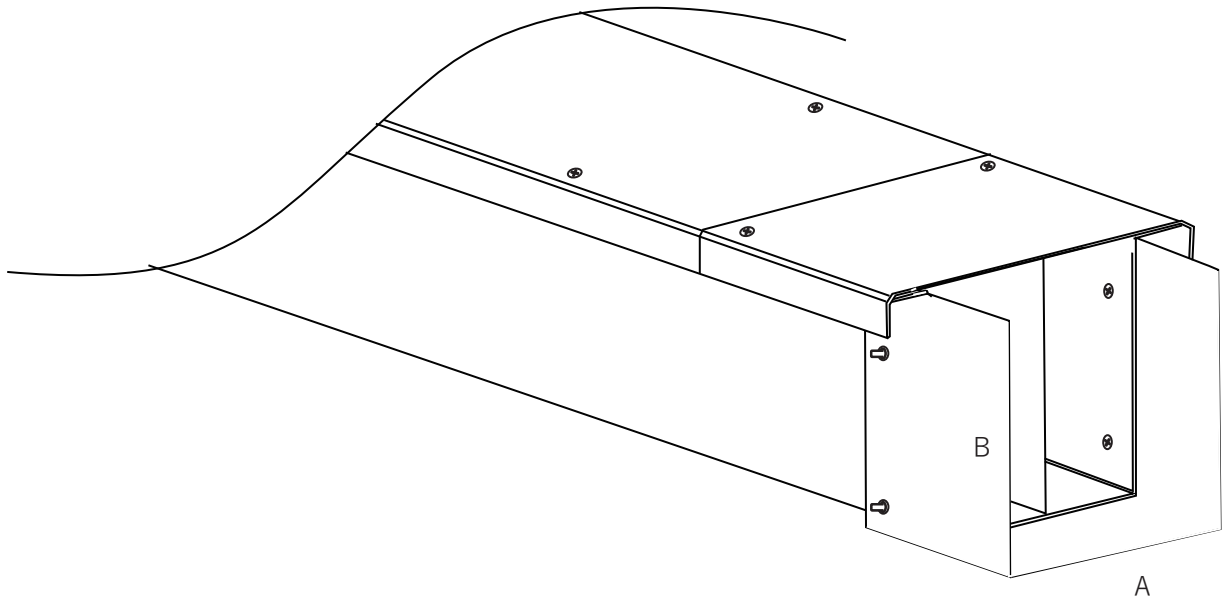

Cable trunking size 槽尺寸 (mm)	Dimension 尺寸 (mm)		Model Number 型號	
	A	B	Waterproof Cable Trunking 防水槽	Multi-Compartment Waterproof Cable Trunking 分格式防水槽
75 x 50	75	50	WT3X2T12	WT3X2T12D
75 x 75	75	75	WT3X3T12	WT3X3T12D
100 x 75	100	75	WT4X3T12	WT4X3T12D
100 x 100	100	100	WT4X4T14	WT4X4T14D
150 x 100	150	100	WT6X4T14	WT6X4T14D
150 x 150	150	150	WT6X6T16	WT6X6T16D
200 x 150	200	150	WT8X6T16	WT8X6T16D
200 x 200	200	200	WT8X8T16	WT8X8T16D

Other sizes can be custom made 其他尺寸可按客戶要求生產

Waterproof Trunking Accessories 防水線槽配件

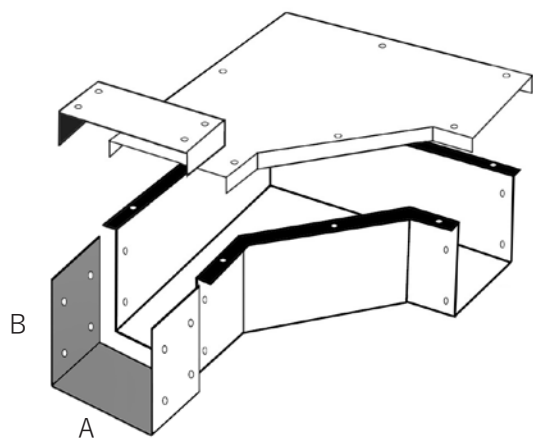

90 degree bend 90度曲

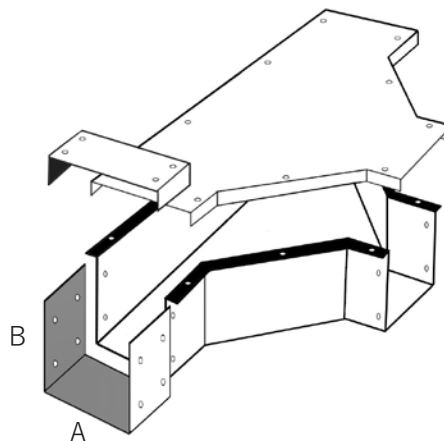

Tee bend 三叉曲

For Cable trunking size 配槽尺寸 (mm)	Dimension 尺寸 (mm)		Model Number 型號	
	A	B	90 degree bend 90度曲	Tee bend 三叉曲
75 x 50	75	50	WT3X2.1T12	WT3X2.3T12
75 x 75	75	75	WT3X3.1T12	WT3X3.3T12
100 x 75	100	75	WT4X3.1T12	WT4X3.3T12
100 x 100	100	100	WT4X4.1T14	WT4X4.3T14
150 x 100	150	100	WT6X4.1T14	WT6X4.3T14
150 x 150	150	150	WT6X6.1T16	WT6X6.3T16
200 x 150	200	150	WT8X6.1T16	WT8X6.3T16
200 x 200	200	200	WT8X8.1T16	WT8X8.3T16

Skirting Trunking 牆邊線槽

STANDARDS

BS 4678 Part 1 Class 2 & 3 Corrosion Protection, BS1449, BSEN 50085-1,2-1, IEC 61084-1, 2-1, BSEN 10139, EN 10143, BSEN 10149

規格標準

BS 4678 Part 1 Class 2 & 3 抗蝕保護, BS1449, BSEN 50085-1,2-1, IEC 61084-1, 2-1, BSEN 10139, EN 10143, BSEN 10149

TRUNKING COVER TYPE

Screw fix

槽蓋款式

螺絲蓋

MATERIAL

Galvanised Steel Sheet
Mild Steel
Stainless Steel Sheet SS304 (S), SS316 (X)

原料

鍍鋅鋼板
鋼板
不銹鋼板SS304 (S), SS316 (X)

LENGTH

Standard length of 2.44m,
Other lengths available on request

長度

標準2.44m,
其他長度可按照客需要

THICKNESS

Comply to BS 4678
Other thicknesses can be made
(0.9mm -2.0mm)

厚度

符合BS 4678要求
其他厚度由0.9mm -2.0mm 可按要求生產

FINISHES

Hot Dip Galvanized to BS729, ISO1460, 1461 (H)
Coloured Epoxy Powder Coating / High Grade Outdoor Powder (P)

表面處理

熱浸鋅符合標準BS729, ISO1460, 1461 (H)
顏色聚脂油粉 / 高級戶外粉 (P)

SEPARATE COMPARTMENTS

2 compartment (D), or multi compartment (T) as requested

槽內間格

可按照客人的要求製成二倉式(D), 多倉式(T)

Fittings and accessories meet the same standard and specifications as trunkings
線槽配件的規格及標準完全遵照及配合電線槽而製成

Skirting Trunking and Fittings 牆邊線槽及配件

Skirting Trunking 牆邊線槽

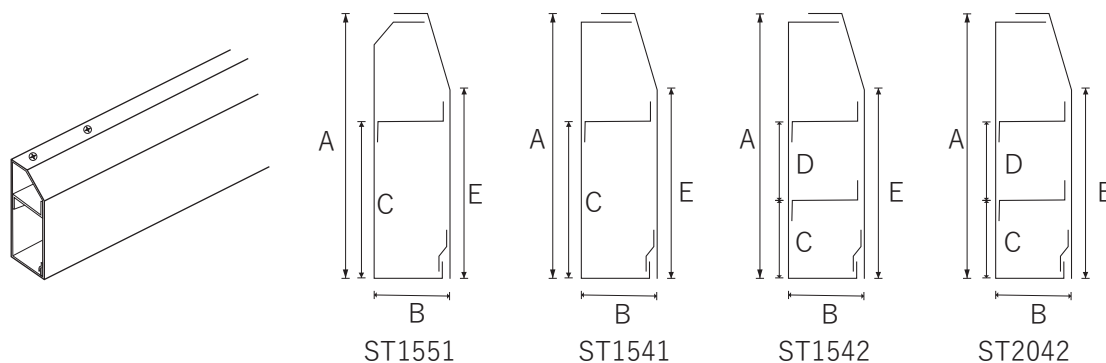

Model Number 型號	Dimension 尺寸 (mm)				
	A	B	C	D	E
ST1551	150	50	100	-	113
ST1541	150	40	100	-	113
ST1542	150	40	75	38	126
ST2042	200	40	100	50	163

90° Bend 90° 曲



Suitable for 適用於	Model Number 型號	
	Internal Opening 內開蓋型	External opening 外開蓋型
ST1551	IB1551	EB1551
ST1541	IB1541	EB1541
ST1542	IB1542	EB1542
ST2042	IB2042	EB2042

Accessories 配件



Suitable for 適用於	Model Number 型號			
	Single Gang Outlet Plate 單制位片	Twin Gang Outlet Plate 雙制位片	End Cap 槽尾封	Connecting Plate 槽駁碼
ST1551	CCS1551	CCD1551	FEC1551	CP1551
ST1541	CCS1541	CCD1541	FEC1541	CP1541
ST1542	CCS1542	CCD1542	FEC1542	CP1542
ST2042	CCS2042	CCD2042	FEC2042	CP2042

Floor trunking types 地槽 - 款式

Raised floor trunking 地台線槽

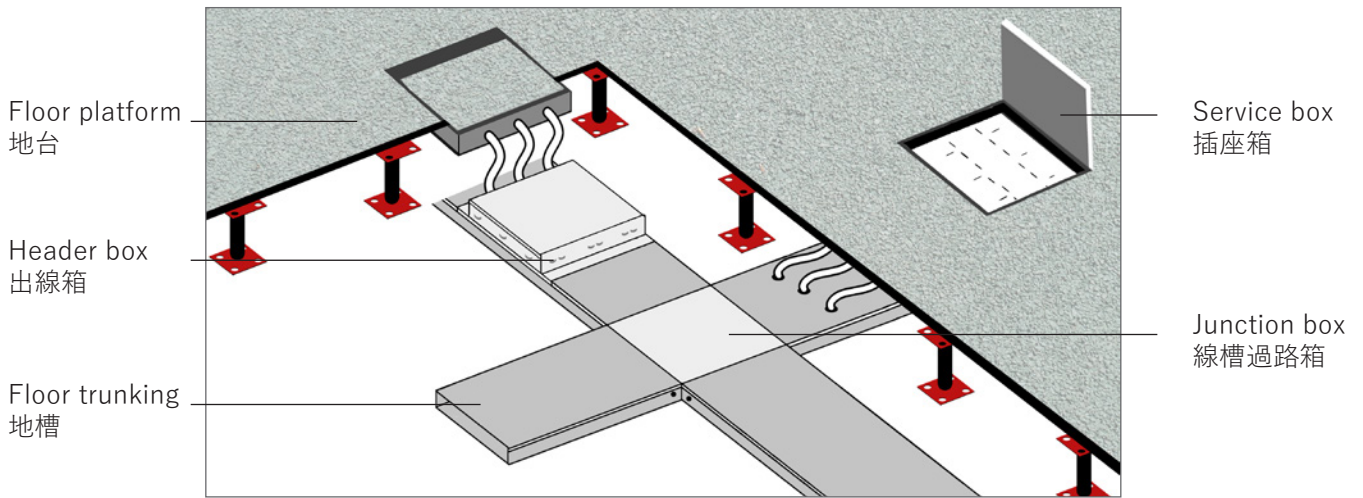

Underfloor trunking 藏地線槽

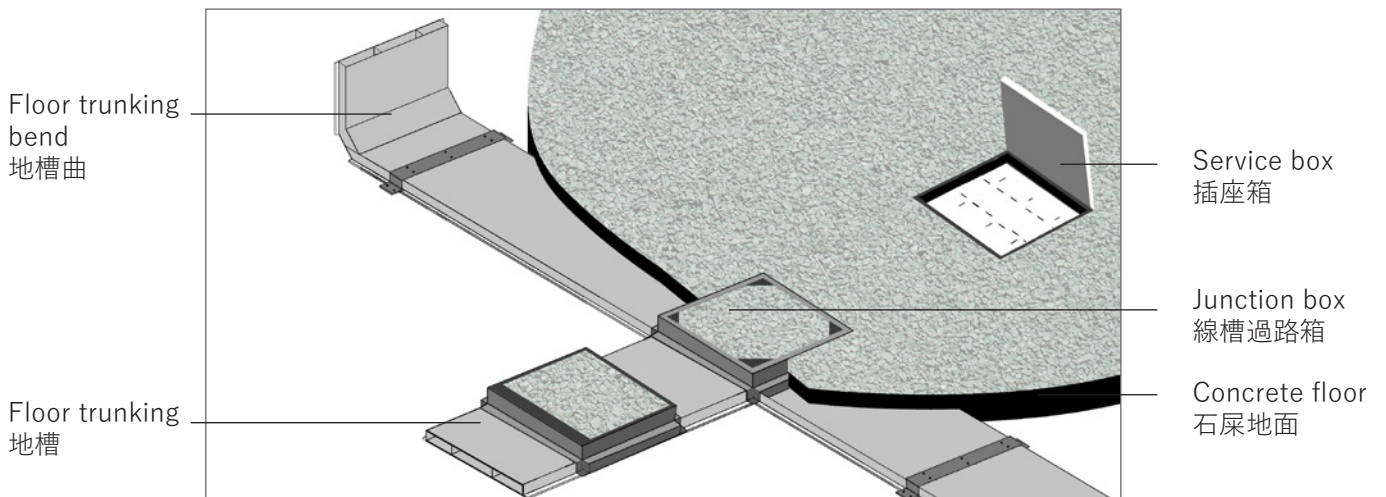

Flushfloor trunking 平地線槽

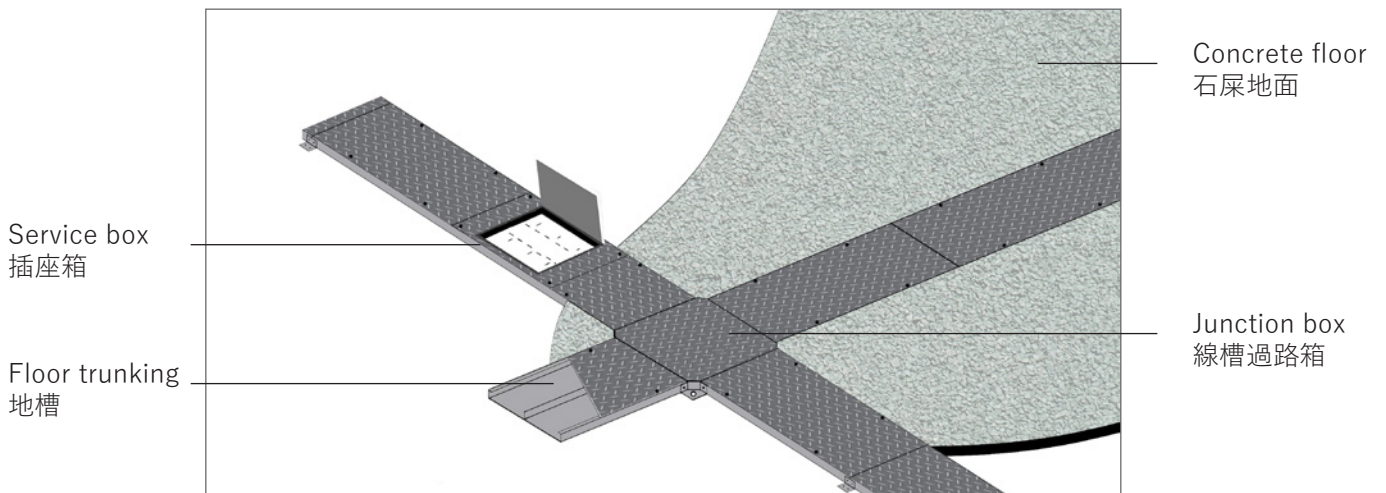

Raised floor trunking 地台線槽

STANDARDS

BS 4678 Part 1 Class 2 & 3 Corrosion Protection, BS1449, BSEN 50085-1, IEC 61084-1, BSEN 10139, EN 10143, BSEN 10149

規格標準

BS 4678 Part 1 Class 2 & 3 抗蝕保護, BS1449, BSEN 50085-1, IEC 61084-1, BSEN 10139, EN 10143, BSEN 10149

TRUNKING COVER TYPE

Centre Caption (QT)
Screw Fix (ST)
Clip Fix (CT)

槽蓋款式

肚臍蓋(QT)
螺絲蓋(ST)
彈夾蓋(CT)

MATERIAL

Galvanised Steel Sheet
Mild Steel
Stainless Steel Sheet SS304 (S), SS316 (X)

原料

鍍鋅鋼板
鋼板
不銹鋼板SS304 (S), SS316 (X)

LENGTH

Standard length of 2.44m,
Other lengths available on request

長度

標準2.44m,
其他長度可按照客需要

THICKNESS

Comply to BS 4678
Other thicknesses can be made
(0.9mm -2.0mm)

厚度

符合BS 4678要求
其他厚度由0.9mm -2.0mm 可按要求生產

FINISHES

Hot dip galvanized to BS729, ISO1460, 1461 (H)
Coloured Epoxy powder coating / High Grade outdoor powder (P)

表面處理

熱浸鋅符合標準BS729, ISO1460, 1461 (H)
顏色聚脂油粉 / 高級戶外粉 (P)

SEPARATE COMPARTMENTS

2 compartment (D), or multi compartment (T) as requested

槽內間格

可按照客人的要求製成二倉式(D), 多倉式(T)

Fittings and accessories meet the same standard and specifications as trunkings
線槽配件的規格及標準完全遵照及配合電線槽而製成

Raised floor trunking and boxes 地台線槽及箱

Raised floor trunking 地台線槽

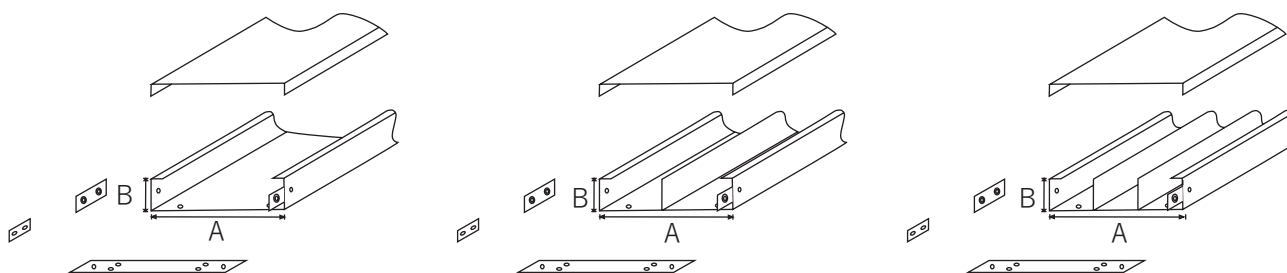

Standard type 標準型

2 compartment type 2 倉型

3 compartment type 3 倉型

Raised floor trunking size 地台槽尺寸 (mm)	Dimension 尺寸 (mm)			Model Number 型號		
	A	B		Standard Type 標準型	2-C Type 2倉型	3-C Type 3倉型
150 x 50	150	50		RF5015	RFD5015	RFT5015
200 x 50	200	50		RF5020	RFD5020	RFT5020
250 x 50	250	50		RF5025	RFD5025	RFT5025
300 x 50	300	50		RF5030	RFD5030	RFT5030
150 x 75	150	75		RF7515	RFD7515	RFT7515
200 x 75	200	75		RF7520	RFD7520	RFT7520
250 x 75	250	75		RF7525	RFD7525	RFT7525
300 x 75	300	75		RF7530	RFD7530	RFT7530

Junction box, Header box 線槽過路箱, 槽頂出線箱

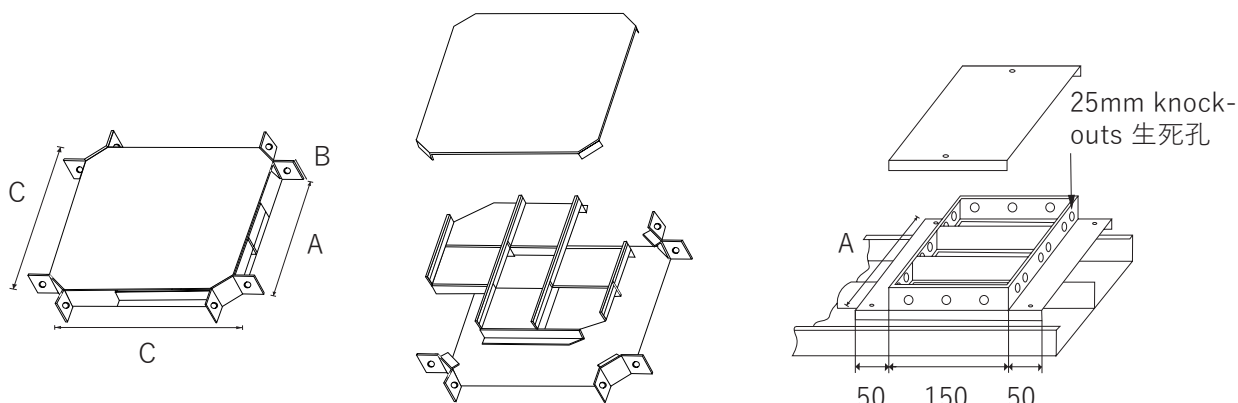

Junction Box 線槽過路箱

Header Box 槽頂出線箱

Raised floor trunking size 地台槽尺寸 (mm)	Dimension 尺寸 (mm)			Model number 型號			Header Box 出線箱
	A	B	C	Standard Type 標準型	Junction Box 線槽箱 2-C Type 2倉型	3-C Type 3倉型	
150 x 50	150	50	250	RJB5015	RJBD5015	RJBT5015	BXHB15
200 x 50	200	50	300	RJB5020	RJBD5020	RJBT5020	BXHB20
250 x 50	250	50	350	RJB5025	RJBD5025	RJBT5025	BXHB25
300 x 50	300	50	400	RJB5030	RJBD5030	RJBT5030	BXHB30
150 x 75	150	75	250	RJB7515	RJBD7515	RJBT7515	BXHB15
200 x 75	200	75	300	RJB7520	RJBD7520	RJBT7520	BXHB20
250 x 75	250	75	350	RJB7525	RJBD7525	RJBT7525	BXHB25
300 x 75	300	75	400	RJB7530	RJBD7530	RJBT7530	BXHB30

Revolutionary semi-circle hinge
allows easy optional lid removal
首創半圓形較位, 簡單設計, 更簡單拆蓋

Panel options and selections available
手抽旁片和蓋面可挑選款式



3-direction (left right front)
silicone-lip wire exits
3邊軟膠出線, 插電隨心所欲

Our award-winning concept, available now 誠意推出獲獎革新概念

The Lik Hung floor service box
力雄LHFB插座箱

Winner of 2018
Asia International
Innovative Invention
Award - Gold
發明大獎 - 金獎

Design led
by multi-
award-winning
German industrial
designer.
德國設計師引領

Design /
features
patented.
獲數項專利

Lid loading rated
to withstand
over 4KN
(400kg)
負載 > 400kg

Side frame made
of glass-fibre
nylon for extra
strength.
框架選用玻璃纖維

IEC(EN) 60670-1
and 60670-23
Lab certified.
IEC 規格認可

Extensive job
refs. (eg. HKIA,
EMSD HQ)
多項實例 (香港機
場, 機電署總部)

Raised floor Service box (New Model 6 way) 地台插座箱 (新款 6位)

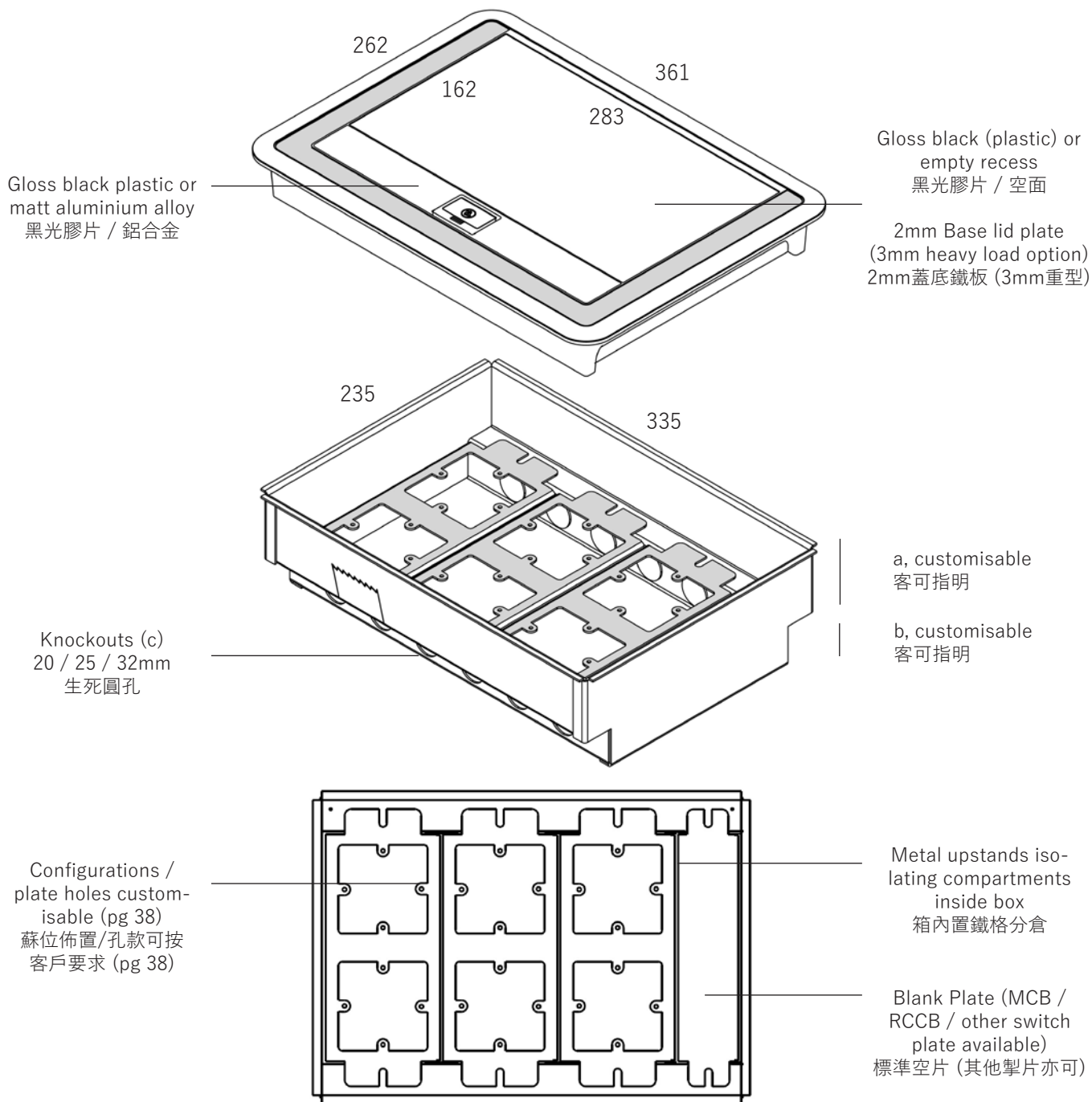

Model Number 型號	Socket number 可配蘇位	Standard model dimensions 標準款式尺寸 (mm)				Standard Socket Configuration 標準蘇位佈置		Main panel options 主面選擇	Handle Panel options 手抽旁片選擇
		a	b	knockout diameter c 生死孔 直徑 c	Lid plate thickness 蓋底鐵板厚	13a socket plate 蘇片	Blank plate 空片	Empty (standard) 空 (標準)	Aluminium alloy (standard) 鋁合金 (標準)
LHFB2525R	6	53	32	20	2	x3	x1	Black plastic 黑膠	Black plastic 黑膠

Bespoke mounting plates / socket numbers can be made / expanded 可要求特款座片或容納更多蘇位

Raised floor Service box (New Model 4,9 way) 地台插座箱 (新款 4,9位)

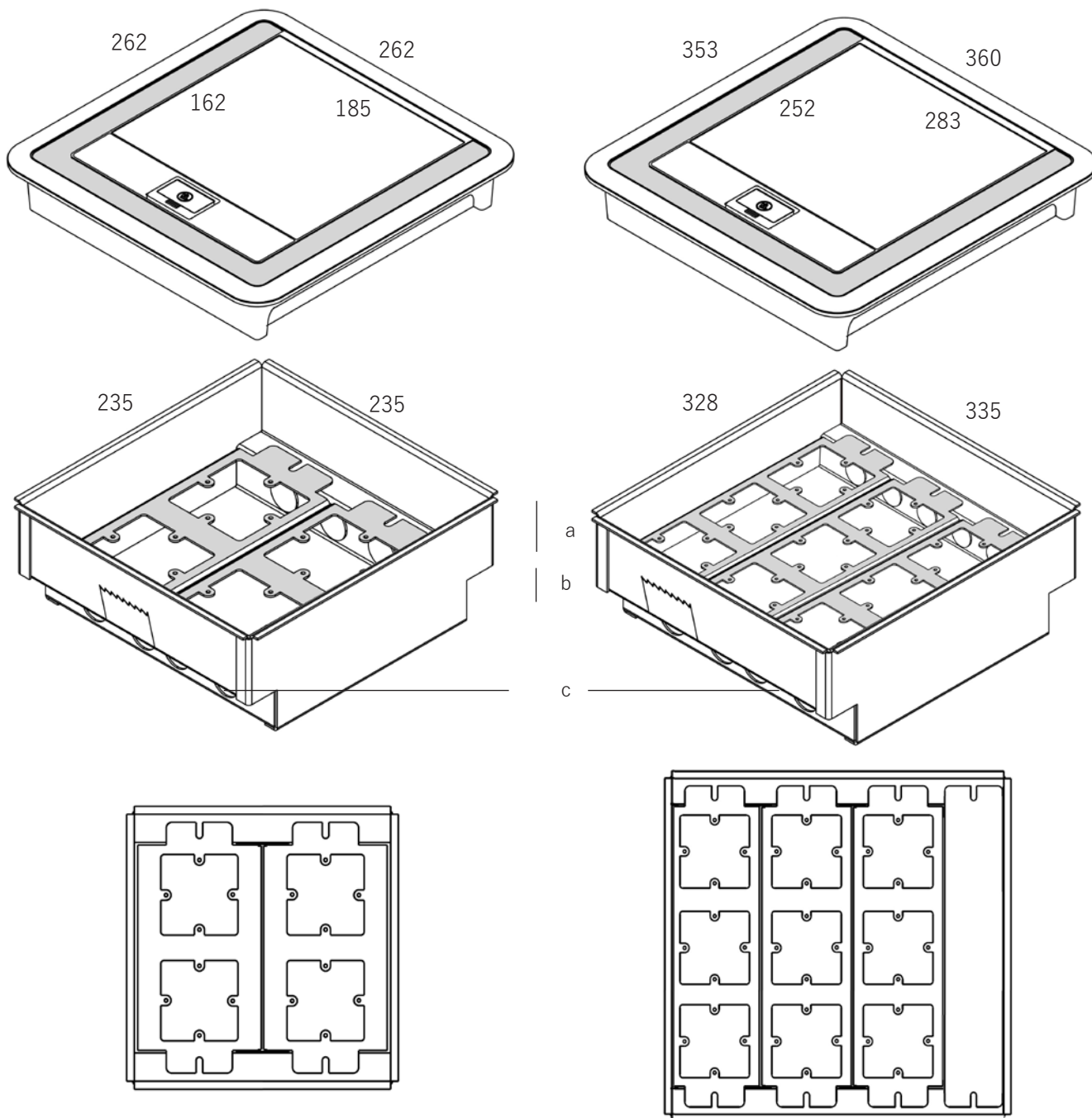

Model Number 型號	Socket number 可配蘇位	Standard model dimensions 標準款式尺寸 (mm)				Standard Socket Configuration 標準蘇位佈置		Main panel options 主面選擇	Handle Panel options 手抽旁片選擇
		a	b	knockout diameter c 生死孔直徑c	Lid plate thickness 蓋底鐵板厚	13a socket plate 蘇片	Blank plate 空片	Empty (standard) 空 (標準)	Aluminium alloy (standard) 鋁合金 (標準)
LHFB2020R	4	53	32	20	2	x2	0		
LHFB3030R	9	53	32	20	2	x3	x1	Black plastic 黑膠	Black plastic 黑膠

Bespoke mounting plates / socket numbers can be made / expanded 可要求特款座片或容納更多蘇位

Socket mounting plates for LHFB 插座箱 - 插座底片

Available for 4, 6, 9 way LHFB boxes 可訂配用於 4, 6, 9位 LHFB 箱

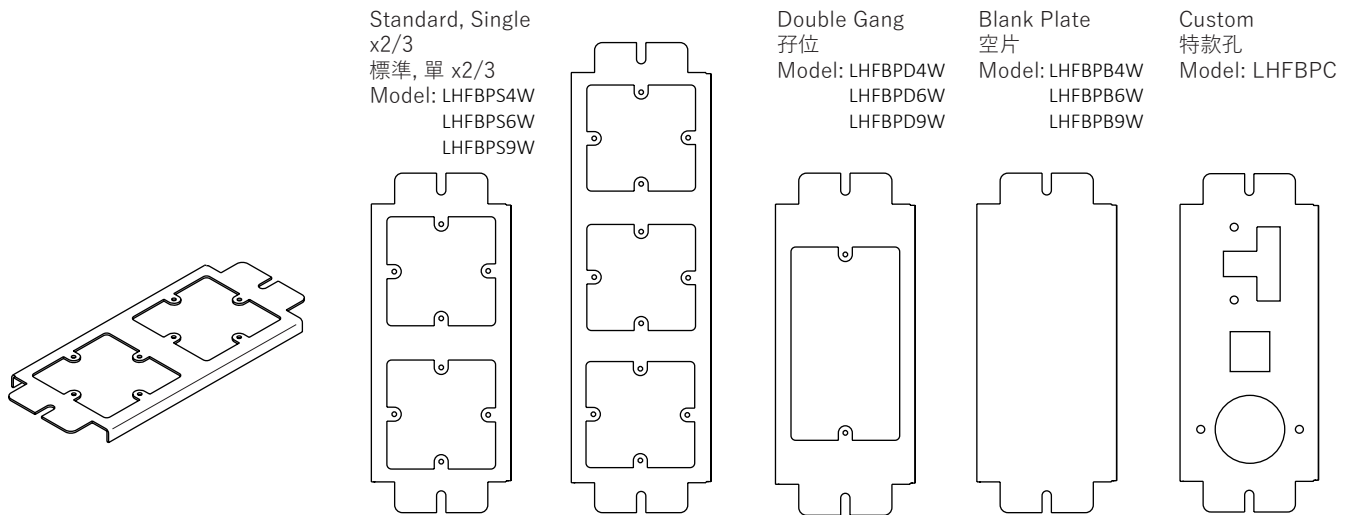

Raised floor Service box (Previous Model) 地台插座箱 (舊款)

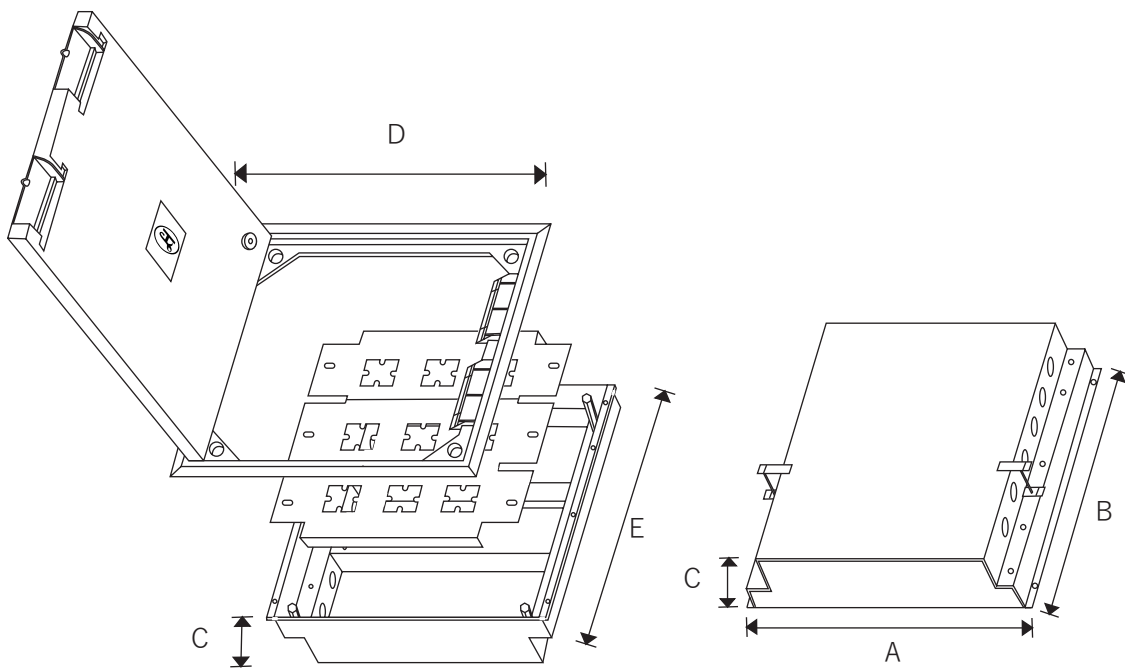

Socket number 蘇位	Dimension 尺寸 (mm)					Model number 型號
	A	B	C	D	E	
6	260	270	75	280	280	SBX2525R
9	330	330	75	355	355	SBX3025R

Underfloor Trunking 藏地線槽

STANDARDS

BS 4678 Part 2 Class 2 & 3 Corrosion Protection, BS1449, IEC 61084-1, 2-2, BSEN 10139, EN 10143, BSEN 10149, IPX4 according to IEC 60529

規格標準

BS 4678 Part 2 Class 2 & 3 抗蝕保護, BS1449, IEC 61084-1, 2-2, BSEN 10139, EN 10143, BSEN 10149, IPX4 (IEC 60529)

TRUNKING COVER TYPE

Completely sealed design, can be connected together to form a distribution network under the floor

槽蓋款式

全密封式設計, 地槽潛藏在地下互相接駁

MATERIAL

Galvanised Steel Sheet
Mild Steel
Stainless Steel Sheet SS304 (S), SS316 (X)

原料

鍍鋅鋼板
鋼板
不銹鋼板SS304 (S), SS316 (X)

LENGTH

Standard length of 2.44m,
Other lengths available on request

長度

標準2.44m,
其他長度可按照客需要

THICKNESS

Comply to HK government projects
Other thicknesses can be made
(0.9mm -2.0mm)

厚度

符合香港政府相關部門要求
其他厚度由0.9mm -2.0mm 可按要求生產

FINISHES

Hot Dip Galvanized to BS729, ISO1460, 1461 (H)
Coloured Epoxy Powder Coating / High Grade Outdoor Powder (P)

表面處理

熱浸鋅符合標準BS729, ISO1460, 1461 (H)
顏色聚脂油粉 / 高級戶外粉 (P)

SEPARATE COMPARTMENTS

2 compartment (D), or multi compartment (T) as requested

槽內間格

可按照客人的要求製成二倉式(D), 多倉式(T)

Fittings and accessories meet the same standard and specifications as trunkings
線槽配件的規格及標準完全遵照及配合電線槽而製成

Underfloor Trunking and bends 藏地線槽及配件

Underfloor trunking 藏地線槽

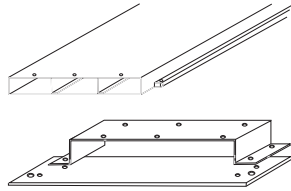

A type (Sealed Lid 密封蓋)

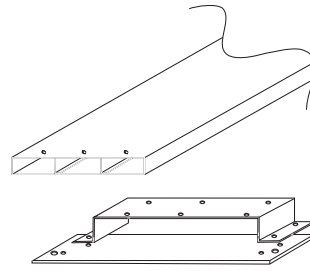

B type (Removable Lid 活動蓋)

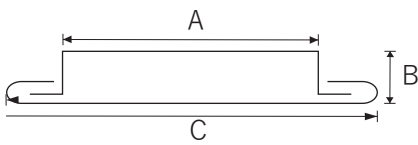

Standard type 標準型

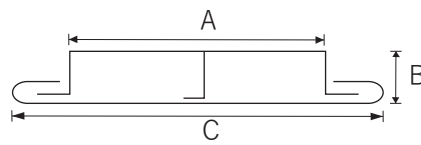

2-compartment type 2 倉型

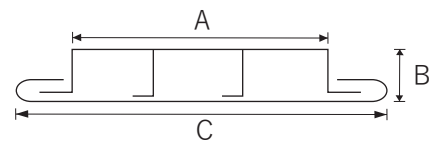

3-compartment type 3 倉型

Underfloor Trunking Size 藏地槽尺寸	Dimension 尺寸 (mm)			Model Number 型號		
	A	B	C	Standard Type 標準型	2-C Type 2倉型	3-C Type 3倉型
225 x 25	225	25	257	UF2525	UFD2525	UFT2525
225 x 32	225	32	257	UF2532	UFD2532	UFT2532
300 x 25	300	25	332	UF3025	UFD3025	UFT3025
300 x 32	300	32	332	UF3032	UFD3032	UFT3032

Bend 槽曲

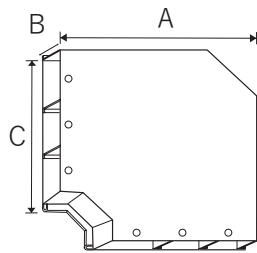

Flat elbow 平面曲

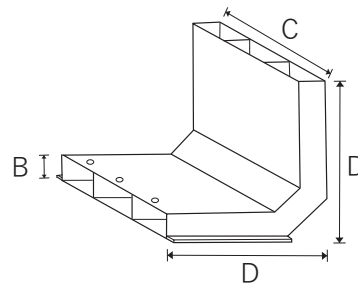

Vertical elbow 垂直曲

Underfloor Trunking Size 藏地槽尺寸	Dimension 尺寸 (mm)				Model Number 型號	
	A	B	C	D	Flat Elbow 平面曲	Vertical Elbow 垂直曲
225 x 25	300	25	225	300	UBH2525	UBV2525
225 x 32	300	32	225	300	UBH2532	UBV2532
300 x 25	375	25	300	375	UBH3025	UBV3025
300 x 32	375	32	300	375	UBH3032	UBV3032

Other sizes can be custom made
其他尺寸可按客戶要求生產

Underfloor Service box (New Model) 藏地插座箱 (新款)

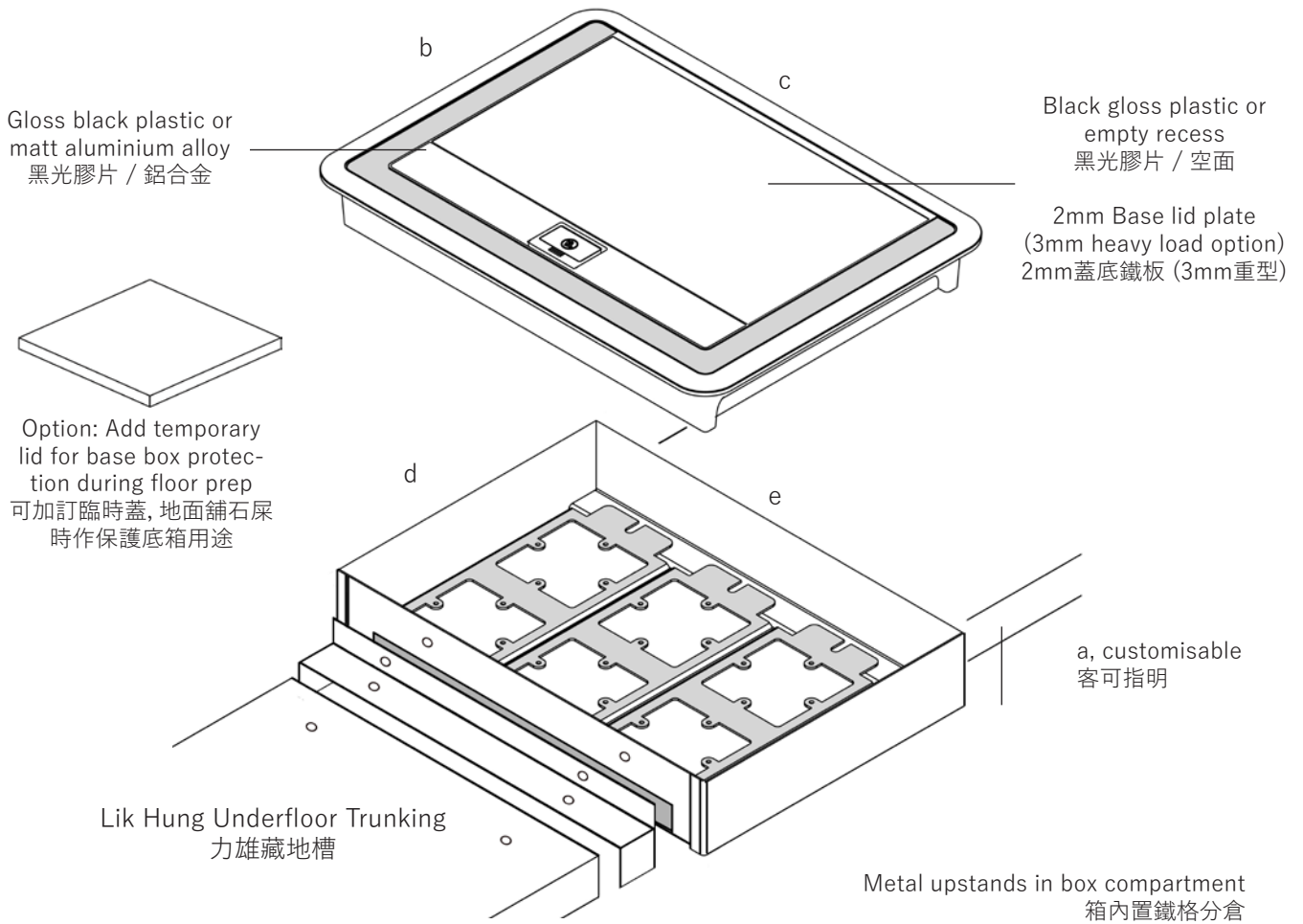
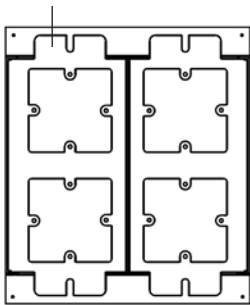
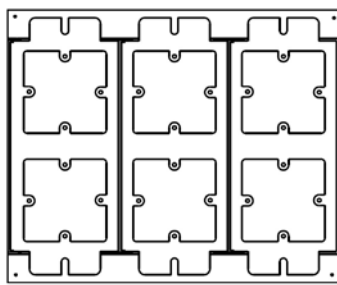

Plate holes customisable (pg 38)
蘇位佈置/孔款可按 客戶要求 (pg 38)



LHFB2020U



LHFB2525U

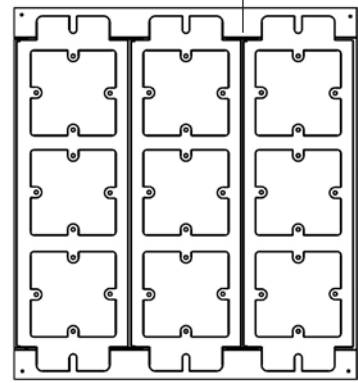

LHFB3030U

Model Number 型號	Socket number 可配蘇位	Standard model dimensions 標準款式尺寸 (mm)					Lid plate thickness 蓋底鐵板厚	13a socket plate # 蘇片 #	Use with number of trunking compartment 配槽格數量	Typically for underfloor trunkings of widths 通常配用槽闊 (mm)	Main panel options 主面選擇	Handle Panel options 手抽旁片選擇
		a	b	c	d	e						
LHFB2020U	4	>70	263	263	236	236	2	2	1/2/3	<230	Empty (standard) 空 (標準)	Aluminium alloy (standard) 鋁合金 (標準)
LHFB2525U	6	>70	263	360	236	337	2	3	1/2/3	<320	Black plastic 黑膠	Black plastic 黑膠
LHFB3030U	9	>70	353	360	328	338	2	3	1/2/3	<320	Black plastic 黑膠	Black plastic 黑膠

Underfloor Junction box (New Model) 藏地槽箱 (新款)

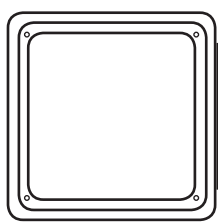
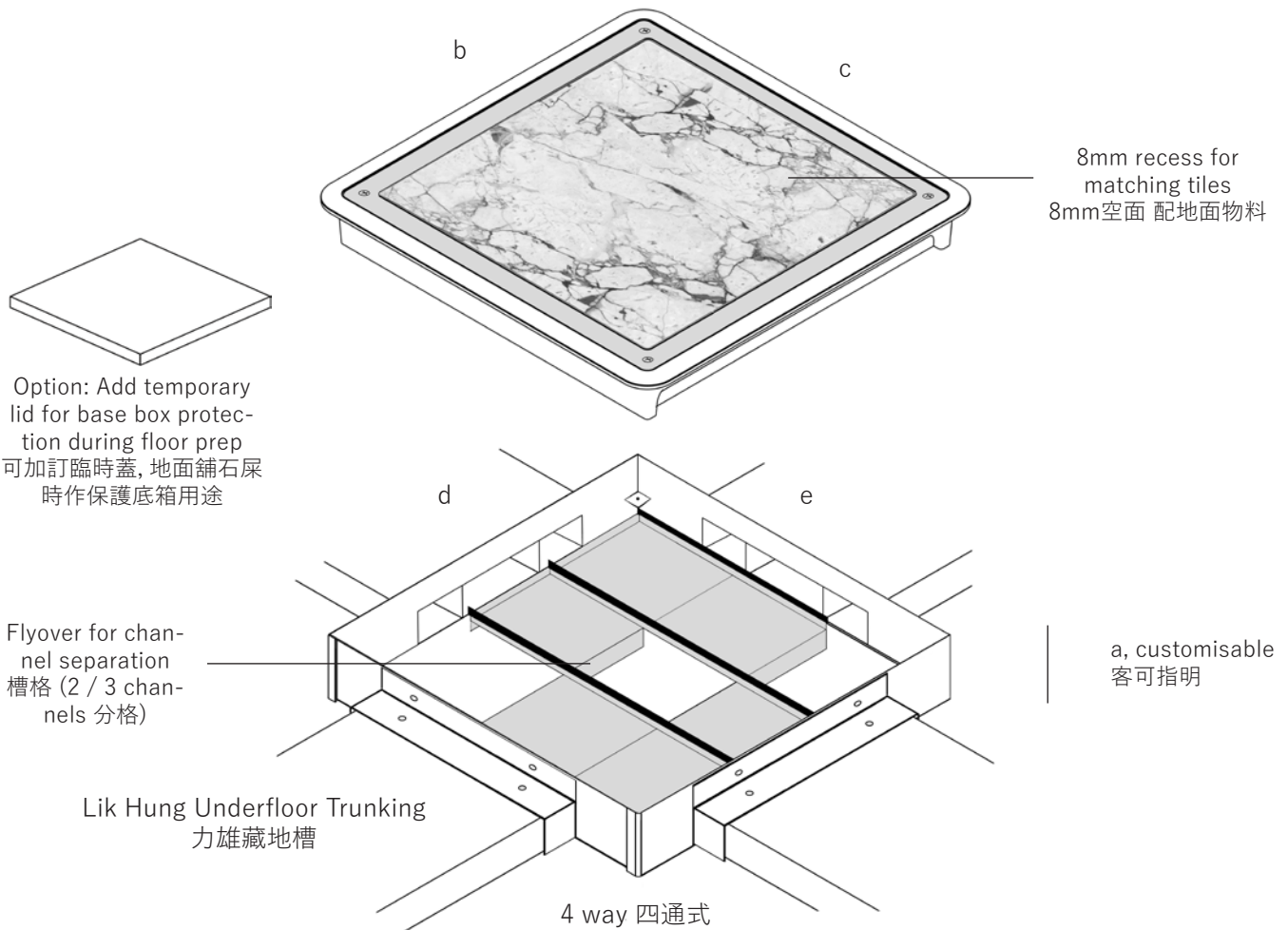

Terminal 終尾式

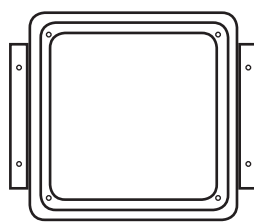

Through 直通式

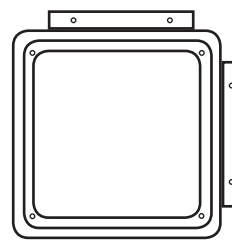

Elbow 轉角式

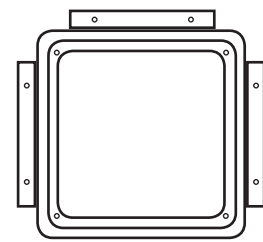

Tee 三通式

Model Number 型號	Standard model dimensions 標準款式尺寸 (mm)					Use with number of trunking compartment 配槽格數量	Typically for underfloor trunkings of widths 通常配用槽闊 (mm)
	a	b	c	d	e		
LHJB2020U	>70	263	263	237	237	1 / 2 / 3	< 230
LHJB3030U	>70	354	361	328	337	1 / 2 / 3	< 320

Underfloor Service/Junction box (Previous Model) 藏地插座箱/槽箱 (舊款)

Underfloor Service box (Previous Model) 藏地插座箱 (舊款)

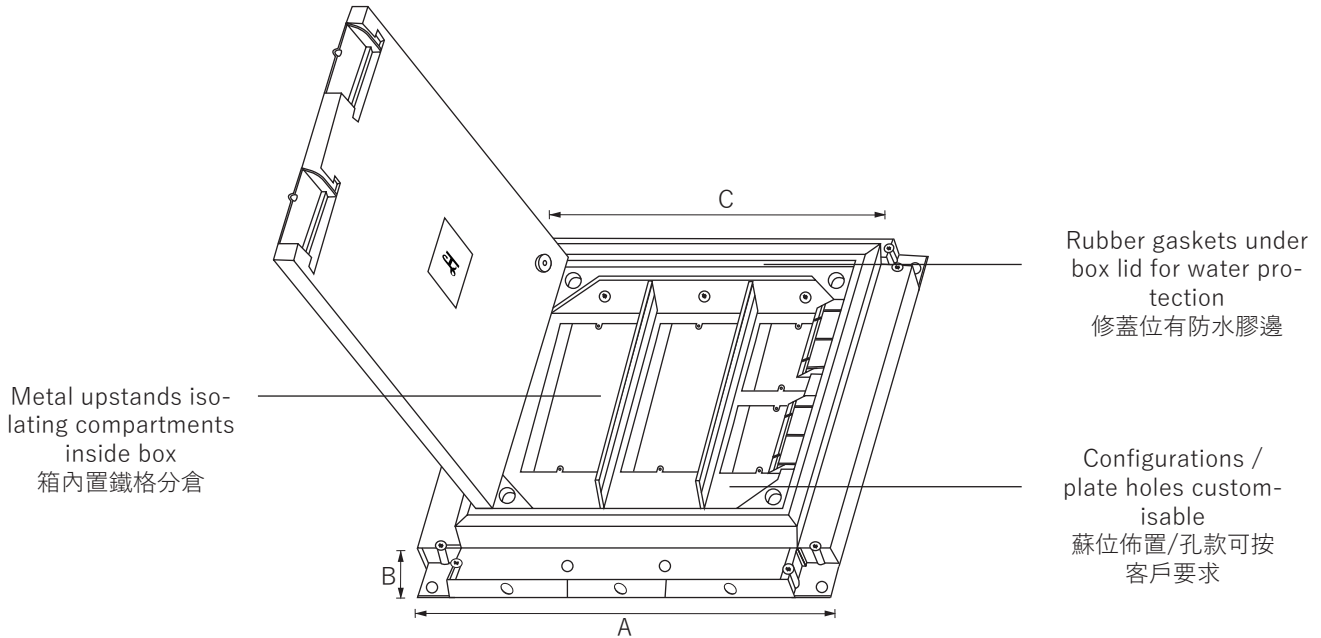

Underfloor Trunking Size 藏地槽尺寸	Socket number 可配蘇位	Dimension 尺寸 (mm)			Model Number 型號
		A	B	C	
225 x 25	6	320	72	280	SBX2525
225 x 32	6	320	79	280	SBX2532
300 x 25	9	395	72	355	SBX3025
300 x 32	9	395	79	355	SBX3032

Underfloor Junction box (Previous Model) 藏地槽箱 (舊款)

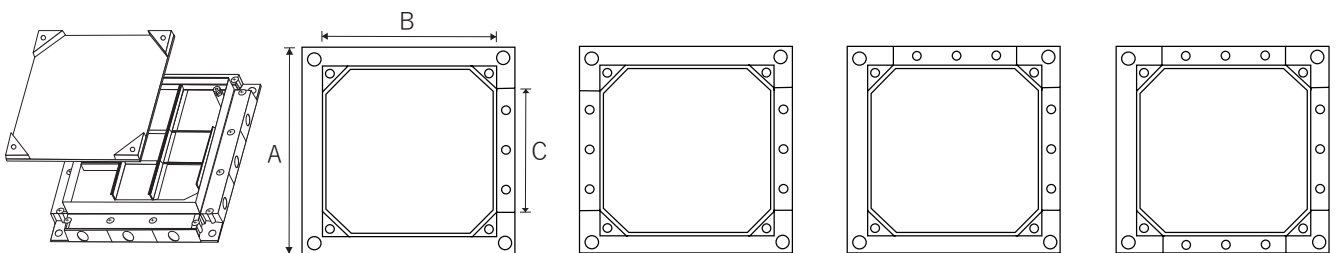

4 way 四通式

Terminal 終尾式

Through 直通式

Elbow 轉角式

Tee 三通式

Underfloor Trunking Size 藏地槽尺寸	Dimension 尺寸 (mm)			Model Number 型號				
	A	B	C	4-way 4通式	Terminal 終尾式	Through 直通式	Elbow 轉角式	Tee 3通式
225 x 25	320	280	230	4JB2525	SJB2525	TJB2525	LJB2525	3JB2525
225 x 32	320	280	230	4JB2532	SJB2532	TJB2532	LJB2532	3JB2532
300 x 25	395	355	305	4JB3025	SJB3025	TJB3025	LJB3025	3JB3025
300 x 32	395	355	305	4JB3032	SJB3032	TJB3032	LJB3032	3JB3032

Flush floor trunking 平地線槽

STANDARDS

BS 4678 Part 2 Class 2 & 3 Corrosion Protection, BS1449, IEC 61084-1, BSEN 10139, EN 10143, BSEN 10149

規格標準

BS 4678 Part 2 Class 2 & 3 抗蝕保護, BS1449, IEC 61084-1, BSEN 10139, EN 10143, BSEN 10149

TRUNKING COVER TYPE

Screw fix, with gasket between trunking body and cover. Cover can be made from 3mm thick galvanised steel or hot dip galvanised chequered steel sheet

槽蓋款式

螺絲蓋, 線槽配備防水膠邊, 槽蓋可選用3mm厚鍍鋅鋼板 或 熱浸鋅花鐵板

MATERIAL

Galvanised Steel Sheet
Mild Steel
Stainless Steel Sheet SS304 (S), SS316 (X)

原料

鍍鋅鋼板
鋼板
不銹鋼板SS304 (S), SS316 (X)

LENGTH

Standard length of 2.44m,
Other lengths available on request

長度

標準2.44m,
其他長度可按照客需要

THICKNESS

Comply to HK government projects
Other thicknesses can be made
(0.9mm -2.0mm)

厚度

符合香港政府相關部門要求
其他厚度由0.9mm -2.0mm 可按要求生產

FINISHES

Hot Dip Galvanized to BS729, ISO1460, 1461 (H)
Coloured Epoxy Powder Coating / High Grade Outdoor Powder (P)

表面處理

熱浸鋅符合標準BS729, ISO1460, 1461 (H)
顏色聚脂油粉 / 高級戶外粉 (P)

SEPARATE COMPARTMENTS

2 compartment (D), or multi compartment (T) as requested

槽內間格

可按照客人的要求製成二倉式(D), 多倉式(T)

Fittings and accessories meet the same standard and specifications as the trunkings
線槽配件的規格及標準完全遵照及配合電線槽而製成

Flush floor trunking 平地線槽

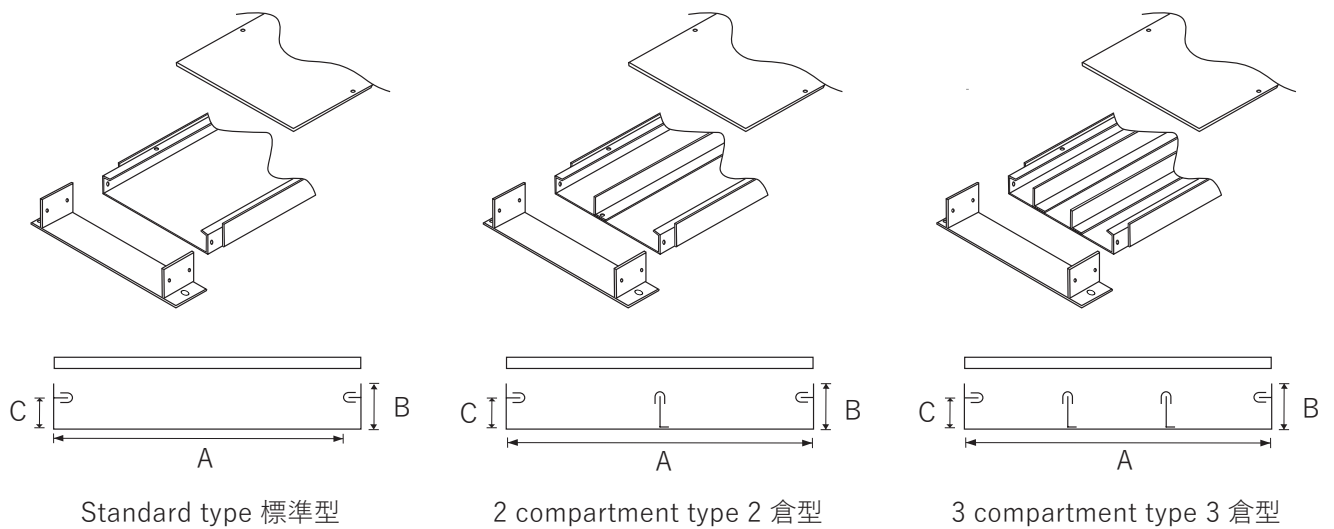

Flushfloor Trunking Size 平地槽尺寸	Dimension 尺寸 (mm)			Model Number 型號		
	A	B	C	Standard Type 標準型	2-C Type 2倉型	3-C Type 3倉型
150 x 50	150	50	47	FF5015	FFD5015	FFT5015
200 x 50	200	50	47	FF5020	FFD5020	FFT5020
250 x 50	250	50	47	FF5025	FFD5025	FFT5025
300 x 50	300	50	47	FF5030	FFD5030	FFT5030
150 x 75	150	75	72	FF7515	FFD7515	FFT7515
200 x 75	200	75	72	FF7520	FFD7520	FFT7520
250 x 75	250	75	72	FF7525	FFD7525	FFT7525
300 x 75	300	75	72	FF7530	FFD7530	FFT7530

Other sizes can be custom made
其他尺寸可按客戶要求生產

Flush floor trunking Bend and Box 平地線槽曲及箱

Flush floor trunking Bend 平地線槽曲

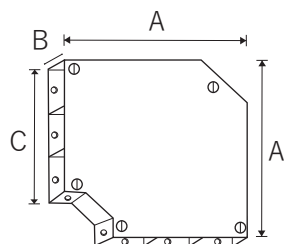

Flat elbow 平面曲

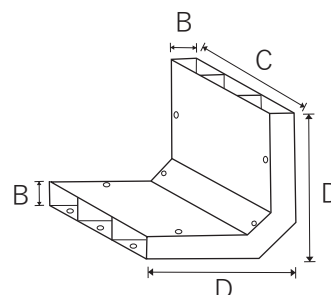

Vertical elbow 垂直曲

Flushfloor Trunking Size 平地槽尺寸	Dimension 尺寸 (mm)				Model Number 型號	
	A	B	C	D	Flat Elbow 平面曲	Vertical Elbow 垂直曲
150 x 50	275	50	150	275	FBH5015	FBV5015
200 x 50	325	50	200	325	FBH5020	FBV5020
250 x 50	375	50	250	375	FBH5025	FBV5025
300 x 50	425	50	300	425	FBH5030	FBV5030
150 x 75	275	75	150	275	FBH7515	FBV7515
200 x 75	325	75	200	325	FBH7520	FBV7520
250 x 75	375	75	250	375	FBH7525	FBV7525
300 x 75	425	75	300	425	FBH7530	FBV7530

Flush floor Junction Box 平地線槽箱

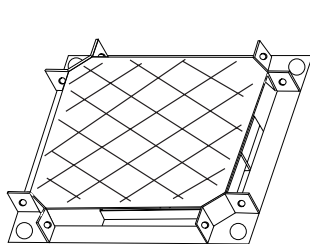

4 way 四通式

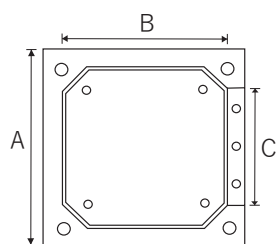

Terminal 終尾式

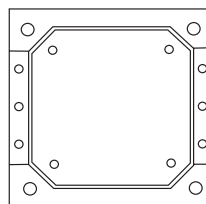

Through 直通式

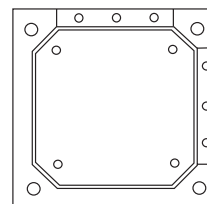

Elbow 轉角式

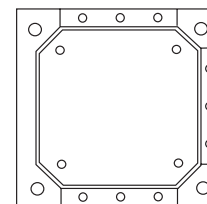

Tee 三通式

Flushfloor Trunking Size 平地槽尺寸	Dimension 尺寸 (mm)			Model Number 型號				
	A	B	C	4-way 4通式	Terminal 終尾式	Through 直通式	Elbow 轉角式	Tee 3通式
150 x 50	250	200	155	4FB5015	SFB5015	TFB5015	LFB5015	3FB5015
200 x 50	300	250	205	4FB5020	SFB5020	TFB5020	LFB5020	3FB5020
250 x 50	350	300	255	4FB5025	SFB5025	TFB5025	LFB5025	3FB5025
300 x 50	400	350	305	4FB5030	SFB5030	TFB5030	LFB5030	3FB5030
150 x 75	250	200	155	4FB7515	SFB7515	TFB7515	LFB7515	3FB7515
200 x 75	300	250	205	4FB7520	SFB7520	TFB7520	LFB7520	3FB7520
250 x 75	350	300	255	4FB7525	SFB7525	TFB7525	LFB7525	3FB7525
300 x 75	400	350	305	4FB7530	SFB7530	TFB7530	LFB7530	3FB7530

Common Fitting Types 常用槽曲款式

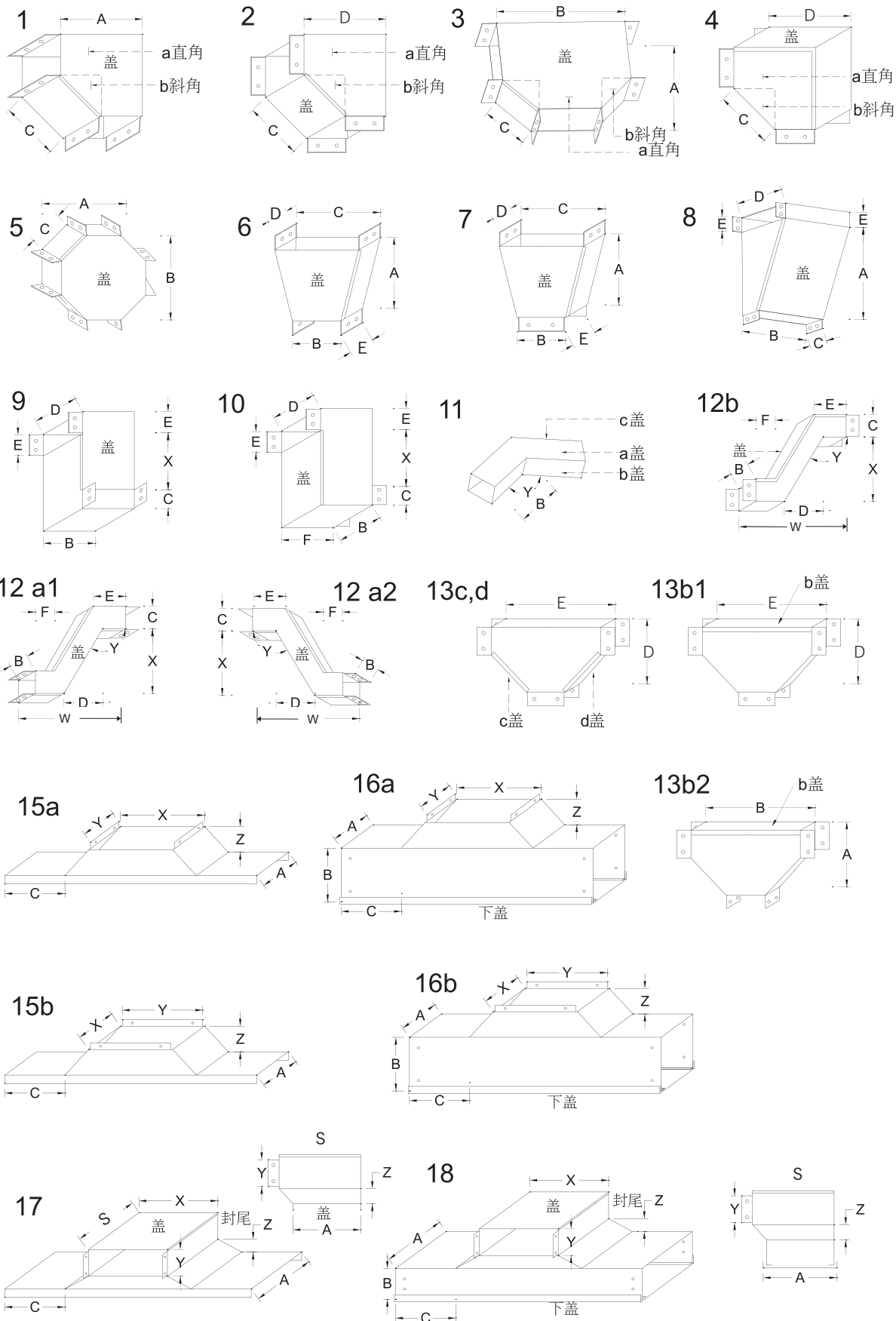

Notation for bend openings dimension 曲口尺寸編號 (e.g. E=100x100, D = 50x50):



Cable Capacity 電線容量

Trunking size is determined by firstly multiplying the number of each conductor by the appropriate corresponding factor shown in table A. The total amount is compared with the factor shown in chart B. This second factor should either equal or exceed the total first conductor factor amount used.

根據安全準則,電線槽內的電線容量,應以下列兩表作為參考,即電線槽的數值應相等或高於所藏電線的數值總和。

Table A - Factor for Cable 電線的數值表

Type of conductor 電線種類	Conductor Cross-sectional area 電線直徑 (mm)	Factor 數值
Solid 單芯電線	1.5	7.1
	2.5	10.2
Stranded 多芯電線	1.5	8.1
	2.5	11.4
	4	15.2
	6	22.9
	10	36.3

Chart B - Trunking Dimension 電線槽尺寸



Data is for reference and should be used only as a guide
數據只作參考

Hong Kong - Office + Warehouse 1

G/F, Unit B, Mai Luen Industrial Building,
23 - 31 Kung Yip St, Kwai Chung
Tel: + 852 2743 7827
Fax: +852 2785 7655
@: sale@likhung.com.hk

Hong Kong - Warehouse 2

3C, Mai Luen Industrial Building,
23 - 31 Kung Yip St, Kwai Chung

Mainland - Factory

Wei Xing Road, Yantian District,
Fenggang Town, China

香港 - 營業部 + 主倉

葵涌 工業街 23-31號
美聯工業大廈 B座地下
電話: +852 2743 7827
傳真: +852 2785 7655
@: sale@likhung.com.hk

香港 - 分倉

葵涌 工業街 23-31號
美聯工業大廈 3C

中國大陸 - 工廠

東莞力雄五金電器塑膠製品有限公司
鳳崗鎮 雁田管理區 圍興路

